



PRIV
Version: 6.0

User Guide

Contents

Setup and basics	5
Your device at a glance.....	5
Insert the SIM card.....	6
Insert a media card.....	7
Turn your device on or off.....	8
Move between home screens.....	8
Get around with navigation buttons.....	9
Touch screen gestures.....	9
Personalizing your device.....	14
Find help for apps.....	14
Phone and voice	15
Phone call icons.....	15
Find your own phone number.....	15
Change your ringtone.....	15
Make a call.....	16
Answer or dismiss a call.....	17
Blocking calls.....	18
Bluetooth enabled headsets.....	19
View your call history.....	20
Phone settings.....	20
LTE calling.....	22
Wi-Fi calling.....	24
Wireless & networks	25
Connections.....	25
Settings	46
Change your device settings.....	46
Display.....	46
Notifications.....	49

Storage & USB.....	55
Battery and power.....	59
Users.....	64
Advanced interactions.....	66
Location.....	68
Accounts.....	69
Backup & reset.....	70
Accessibility.....	72
Update your device software.....	74
Printing.....	75
Security.....	77
Locks, passwords, and protecting your data.....	77
Finding and protecting a lost device.....	84
Security settings.....	86
Google™ apps.....	91
Find help for Google™ apps.....	91
Download an app on Google Play™.....	91
About the Google™ app and Now on Tap.....	91
Google Chrome™.....	91
Google Maps™.....	92
Google Messenger.....	92
Legal notice.....	93

Setup and basics

Your device at a glance



1. Nano SIM card tray
2. Media card (microSD card) tray
3. Notification LED
4. Front camera
5. Volume up

6. Mute
7. Volume down
8. Headset jack
9. Multi-function port (supports USB and video)
10. Power on/off key: Press to lock the screen; press and hold to power on/off; press and hold for 10 seconds to reset
11. NFC sweet spot

Insert the SIM card

Your device uses a nano SIM card. If you don't have a SIM card or don't have the right type of SIM card, contact your service provider.

CAUTION: Do not use a larger SIM card that was cut to a smaller size. Your device might not recognize the SIM card, or the SIM card might get stuck because it is thicker than a nano SIM card.

1. Position your device so you can see the back cover and the top of the device.
2. Release the SIM card tray by pushing the tip of the tool (provided in the box) into the hole on the top-right side of your device. If you don't have the tool that came with your device, you can also use a paper clip.

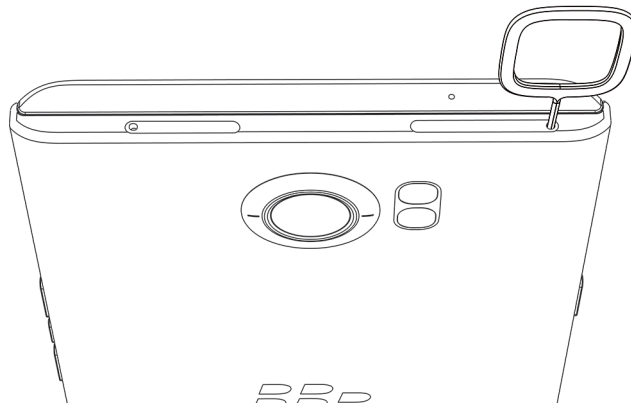

3. Pull out the tray completely and set it on a flat surface.
4. Hold the SIM card so that the metal contacts are facing down and the notch is aligned with the notch in the tray.
5. Put the SIM card in the tray.

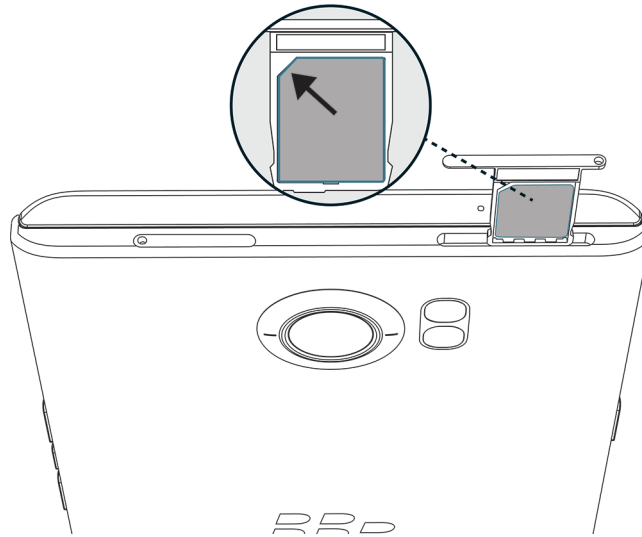

6. Push the tray back into the slot.

Insert a media card

If you want more storage for pictures, videos, music, and documents, you can insert a media card (microSD card).

1. Position your device so you can see the back cover and the top of the device.
2. Release the media card tray by pushing the tip of the tool (provided in the box) into the hole on the top-left side of your device. If you don't have the tool that came with your device, you can also use a paper clip.

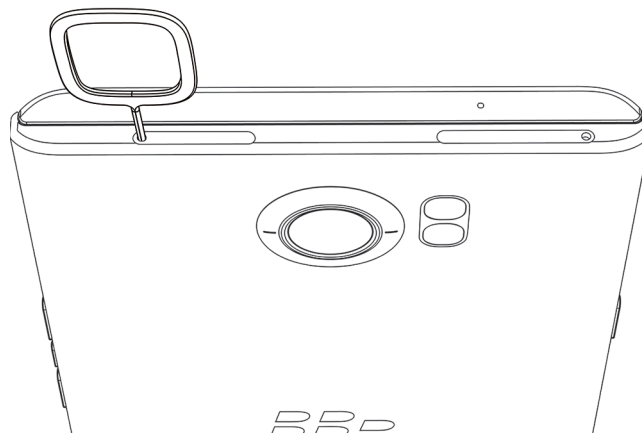

3. Pull out the tray completely and set it on a flat surface.
4. Hold the media card so that the metal contacts are facing down and the notch is aligned with the notch in the tray.
5. Put the media card in the tray.

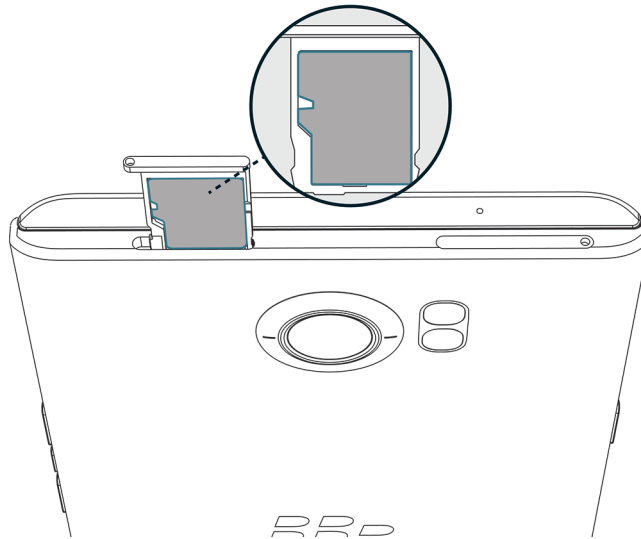

6. Push the tray back into the slot.

Turn your device on or off

Press and hold the **Power on/off** key (on the left side of your device).

- To turn off your device, tap **Power off**.
- To turn your device off and then on again, tap **Restart**.

Turn off the screen

Press the **Power on/off** key (on the left side of your device).

To turn the screen back on, press the **Power on/off** key, or tap the screen twice.

Move between home screens

You can move between your home screens with a gesture on the screen.

On the screen, swipe left or right.

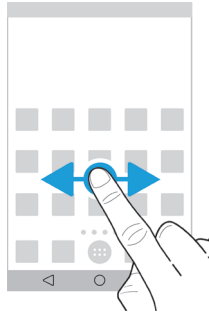

Tip: You can also move between your home screens by swiping left or right on the physical keyboard, or by moving your finger across the dots that appear above the favorites tray.

Get around with navigation buttons

No matter what you're doing on your device, navigation buttons appear at the bottom of your screen.

Do any of the following:

- To go back to the previous screen, tap ◀.
- To go to your home screen, tap ○.
- To see your recently opened apps and screens, tap □.

Touch screen gestures

Take a moment to learn the common gestures that you can use on the touch screen.

Wake up your device

Tap the screen twice.

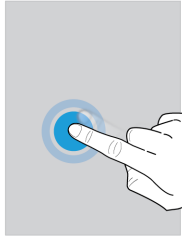

Select items

Do any of the following:

- To select an item, tap it. If the item can be opened, it opens.
- To select multiple items, such as photos that you want to share or email messages that you want to delete, touch and hold one item. Tap more items. To clear an item, tap it again.

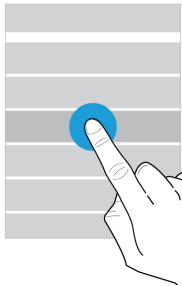

Scroll or move between items

Slide your finger to scroll through a list or move between items, such as photos.

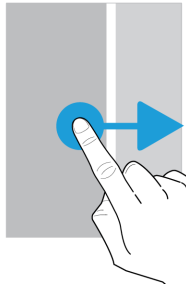
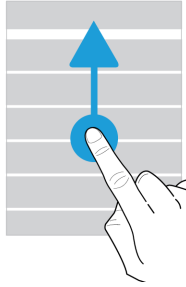

Check your notifications

You can check your latest notifications (for example, email messages and text messages) at any time.

Swipe down from the top of the screen. Tap a notification to open it or pull down to see more notifications.

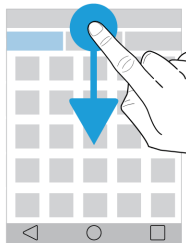

Open Quick Settings

You can open Quick Settings to turn on or turn off common settings such as Wi-Fi and airplane mode.

Swipe down from the top of the screen once using two fingers, or twice using one finger.

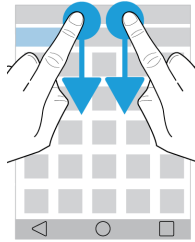

Open an app

You can open one of three default apps from anywhere on your device.

Slide your finger up from the bottom of the screen. Move your finger over the app that you want to open. Lift your finger.

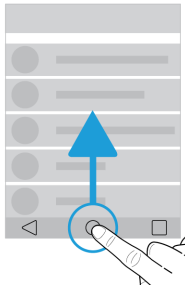

Use a slider

If a slider appears on your screen, you can progress through a file, such as a song or video, or adjust a setting, such as the screen brightness.

Drag the slider handle to the right or left.

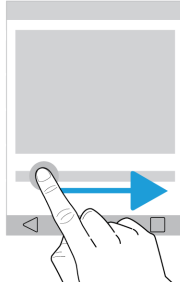

Zoom in to or zoom out from the screen

If you want to see something in more detail, such as a photo or part of a map, you can magnify the image.

To zoom in, slide two fingers apart.

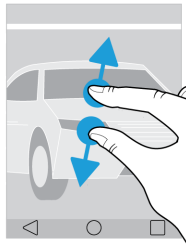

To zoom out, slide two fingers together.

Tip: In some cases, you can tap twice to zoom in or zoom out.

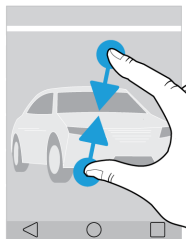

Personalizing your device

Learn how to personalize your device and make it uniquely yours. For example, you can change your ringtone or set a picture as your wallpaper.





- [Change your device settings](#)
- [Change your ringtone](#)
- [Change your wallpaper](#)
- [Speed dial](#)
- [Add an app, a widget, or a shortcut to your home screen](#)
- [Change your font size](#)
- [Change how you view your recent apps and screens](#)
- [Set up or change a screen lock](#)

Find help for apps

You can learn about apps, such as BlackBerry Hub, BlackBerry Calendar, BlackBerry Camera, DTEK by BlackBerry, and more, at help.blackberry.com.

Phone and voice

Phone call icons

Icon	Description
	Turn on the speakerphone
	Put yourself on mute Tip: You can also press the Mute key.
	Put a call on hold
	Show the dial pad
	Make another call (puts your current call on hold)

Find your own phone number

Open the Phone app. Your phone number appears at the top of the screen.

If your phone number doesn't appear at the top of the screen, your service provider might not have added your phone number to your SIM card. For more info, contact your service provider.







Change your ringtone

1. Swipe down from the top of the screen once using two fingers, or twice using one finger.
2. Tap  > **Sound & notification** > **Phone ringtone**.
3. Tap a ringtone, and then tap **OK**.

Tip: To use a song or a custom sound as your ringtone, move the .mp3 file you want to use to the **Ringtones** folder on your device. You might need to install a file manager app from the Google Play™ store first.

Make a call

In the Phone app, do one of the following:



- To dial a number, tap  and enter the number. Tap .
- To call a recent number, on the  tab, beside a name or number, tap .
- To call a contact, on the  tab, tap the contact. Tap the contact's number.
- To call a favorite, on the  tab, tap a contact.

Speed dial

For numbers that you want to be able to call quickly, you can save them to your favorites or add shortcuts to your home screen.

Note: To learn how to create a shortcut for a key on the physical keyboard, see [Keyboard shortcuts](#).

Add a contact to your favorites in the Phone app

1. In the Phone app, on the  tab, tap a contact.
2. Tap .

To remove the contact from your favorites, touch and hold the contact. Drag the contact over , and then release your finger.





Add a phone number to your home screen

You can add a phone number shortcut to your home screen. When you want to call the number, just tap the shortcut.

1. On the home screen, tap .
2. Tap **Shortcuts**.
3. Touch and hold the **Direct dial** shortcut, and then, when the home screen appears, release your finger.
4. Tap a number.



Start a conference call

To be able to answer a call when you're already on a call, you must [turn on call waiting](#).

1. Start a call with the first participant.
2. To add another participant, do one of the following:
 - To call the participant, tap . Dial a number, or tap above the dialpad, find the contact you want to call, tap the contact, and tap .
 - Have the participant call you. To answer the call, touch and hold . Slide your finger until it covers  and then release your finger. Tap **Hold current call**.
3. To merge the calls, tap .





To add more people to the conference call, repeat steps 2 to 3.

Remove people from a conference call

1. In a conference call, tap **Manage conference call**.
2. Do one of the following:
 - To remove a person from the conference call and hang up, tap .
 - To remove a person from the conference call and keep them in a separate call, tap .

Answer or dismiss a call



Different options appear depending on whether your device is locked or unlocked.

1. To answer a call, do one of the following:
 - If your device is unlocked, in the call notification, tap **Answer**.
 - If your device is locked, touch and hold , slide your finger until it covers , and then release your finger.
2. To dismiss a call, do one of the following:
 - If your device is unlocked, in the call notification, tap **Dismiss**.
 - If your device is locked, touch and hold , slide your finger until it covers , and then release your finger.

Dismiss a call and send a quick response instead

When you send a quick response, the caller is sent to voicemail and receives your response as a text message. If you don't have voicemail, the caller receives a busy signal instead. To learn how to customize your quick response messages, see [Change your default quick response messages](#).

1. Do one of the following:
 - If your device is unlocked, in the call notification, tap **Reply**.

- If your device is locked, touch and hold , slide your finger until it covers , and then release your finger.
 - Open the slider.
2. Tap a message, or type your own and tap **Send**.

Silence the ringtone when you receive a call

If you receive a call while your sound or vibration notifications are turned on, you can quickly silence your ringtone and stop your device from vibrating. After you silence the ringtone, you can still answer or decline the call.

When you receive an incoming call, press the **Volume up**, **Volume down**, or **Mute** key.

Blocking calls

Block all incoming or outgoing calls

When you block calls, you can stop all incoming or outgoing calls, and prevent all incoming or all outgoing calls when roaming. Contact your service provider for more info on blocking specific phone numbers. Depending on your service provider, this feature might not be supported.



1. In the Phone app, in the upper-right corner of the screen, tap  > **Settings** > **Calls** > **Call blocking**.
2. Select any of the checkboxes.



The first time that you turn on call blocking, you are prompted to create a password to lock your call blocking settings. To change your call blocking password, tap **Change call blocking password**.

Block a caller

You can stop receiving calls from a number by sending them straight to voicemail.

The number must be added to a contact in the Contacts app.



1. In the Contacts app, tap a contact.
2. Tap  > .
3. Select the **All calls to voicemail** checkbox.

Tip: In the Contacts app, create a contact called **Always send to voicemail** and select the **All calls to voicemail** checkbox. If you receive a call that you want to send straight to voicemail in the future, in the Phone app, on the  tab, tap the number. Tap **Add to contact**, and then tap the **Always send to voicemail** contact. Tap .

Limit the phone numbers that you can call

When you turn on fixed dialing numbers, you can make calls and send text messages (SMS or MMS) only to the numbers that you add to the fixed dialing numbers list.

Your service provider must set up your SIM card for this feature. Depending on your service provider, this feature might not be supported.

1. In the Phone app, in the upper-right corner of the screen, tap .
2. Tap **Settings** > **Calls** > **Fixed Dialing Numbers**.
3. Tap **Enable FDN**.
4. Enter the SIM security code provided to you by your service provider.
5. Tap **OK**.
6. Tap **FDN list** >  > **Add contact**.
7. Type a name and phone number.
8. Tap **Save**.

Bluetooth enabled headsets

When you have a Bluetooth enabled headset connected to your device, incoming calls are automatically received on your headset. For more information about Bluetooth technology, and about connecting and pairing with Bluetooth enabled devices, see [Bluetooth technology](#).

Move a call from your headset to your device

1. In the Phone app, while on a call, tap .
2. Do one of the following:
 - To move the call to your device, tap **Handset earpiece**.
 - To move the call to your device speakerphone, tap **Speaker**.



Prevent calls from going to your Bluetooth enabled headset

You can disconnect your Bluetooth enabled headset from the Phone app so that calls are sent to your device instead.

1. Swipe down from the top of the screen once using two fingers, or twice using one finger.

2. Tap **Bluetooth**.
3. Beside the paired headset you want to disconnect, tap .
4. Clear the **Phone audio** checkbox.

View your call history

1. In the Phone app, in the upper-right corner of the screen, tap  > **Call History**.
2. Do any of the following:
 - To see the details of a specific call, tap a name or phone number, and then tap **Call details**.
 - To view missed calls only, tap **Missed**.
 - To delete a call from your call history, tap a name or phone number. Tap **Call details** > .
 - To clear your call history, tap  > **Clear call history** > **OK**.

Phone settings

Set up your voicemail

Depending on your service provider, this feature might not be supported. Contact your service provider for more info.

1. In the Phone app, in the upper-right corner of the screen, tap  > **Settings** > **Calls** > **Voicemail**.
2. Do any of the following:
 - To set up voicemail, tap **Setup**. If the **Voicemail number** field is blank, tap **Voicemail number**, and then enter your voicemail access number. If you don't have a voicemail access number, contact your service provider.
 - To select a notification profile, tap **Sound**.
 - To set the voicemail notification to vibrate, select the **Vibrate** checkbox.

To call your voicemail from the Phone app, touch and hold **1**.

Show or hide your number on outgoing calls

Depending on your service provider, this feature might not be supported.

1. In the Phone app, in the upper-right corner of the screen, tap  > **Settings** > **Calls** > **Additional settings** > **Caller ID**.
2. Tap **Show number** or **Hide number**.

Turn call waiting on or off

Depending on your service provider, this feature might not be supported.

1. In the Phone app, in the upper-right corner of the screen, tap **☰** > **Settings** > **Calls** > **Additional settings**.
2. Tap the **Call waiting** checkbox.

Set up call forwarding

Depending on your service provider, this feature might not be available.

1. In the Phone app, in the upper-right corner of the screen, tap **☰** > **Settings** > **Calls** > **Call forwarding**.
2. To change the number that your calls are forwarded to, tap a call forwarding option and type a number.

Change your default quick response messages

1. In the Phone app, in the upper-right corner of the screen, tap **☰** > **Settings** > **Quick responses**.
2. Tap the quick response you want to change.
3. Type a new message.
4. Tap **OK**.

To reset to the default quick responses, on the **Edit quick responses** screen, tap **☰** > **Reset default app**.

Answer a call with the slider

By default, when you receive a call and open the slider, you decline the incoming call and send a quick response. You can change your settings so that opening the slider answers the call instead.

1. In the Phone app, tap **☰** > **Settings** > **Sounds and vibration** > **Slider actions** > **Slider options for incoming calls**.
2. Tap **Open to answer**.

Tip: To have nothing happen when you open the slider, tap **Do nothing**.

LTE calling

Turn on Voice over LTE and LTE video calling





Voice over LTE and LTE video calling provide high-definition voice and video calling using 4G LTE connections. To use LTE video calling, you must turn on Voice over LTE.



Depending on your service provider, this feature might not be supported. For more information, contact your service provider.

1. Swipe down from the top of the screen once using two fingers, or twice using one finger.
2. Tap .
3. Depending on the available options, do one of the following:
 - Tap **Advanced Calling**.
 - Tap **More > Cellular networks > IMS Settings**.
4. Turn on the **Advanced Calling**, **IMS**, or **Enhanced 4G LTE Services** switch.
5. Turn on the **HD Voice Only**, **Voice over LTE**, or **Enhanced 4G LTE Mode** switch.
6. To turn on video calling, turn on the **HD Video Calling** or **LTE video calling** switch.

Make an LTE video call

If your service provider supports LTE video calling, you can make a video call to contacts who have this feature.

1. In the Phone app, do one of the following:
 - To dial a number, tap , and then enter the number.
 - To call a contact, tap , and then tap a contact.
 - To call a speed dial contact, tap , and then tap a contact.
2. Tap .

Note: Depending on your service provider, you might not be able to make an LTE video call to a contact directly from  or . Instead, call the contact, and then after the call connects, tap  > **Video call**.

Switch to a voice-only call

During a video call, tap .

To switch back to a video call, tap  again.

Switch between the front-facing and rear-facing camera

During a video call, do one of the following:

- Tap .
- Tap  > **Switch camera**.

Put a video call on hold

During a video call, do one of the following:



- Tap .
- Tap  > **Hold call**.

Share video one way

During a voice call, you can share video with the contact you're talking to, if they also have the LTE video calling feature, but the contact doesn't have to share video with you.

1. During a voice call, tap .
2. Tap **One Way Video** or **Transmit Video Share**.

Answer an LTE video call

1. When you receive a call, touch and hold .
2. Do one of the following:
 - To answer the call as a video call, slide your finger until it covers .
 - To answer the call as a voice call, slide your finger until it covers .

Wi-Fi calling

Turn on Wi-Fi calling



Your device might be able to make and receive calls over Wi-Fi networks, even if you have limited or no mobile network coverage.

Depending on your service provider, this feature might not be supported. Contact your service provider for more information.

1. Swipe down from the top of the screen once using two fingers, or twice using one finger.
2. Tap  > **More** > **Wi-Fi calling**.
3. Turn on the **Wi-Fi Calling** switch.
4. To see when your device will make Wi-Fi calls, turn on **Wi-Fi Calling Status**.
5. Tap **Wi-Fi calling preferences** > **Connection preferences**.
 - To use a Wi-Fi network, even when you have a cellular signal, tap **Wi-Fi preferred**.
 - To never use a cellular network and only use a Wi-Fi network, tap **Wi-Fi only**.
 - To only use a Wi-Fi network for calls when you don't have a cellular signal, tap **Cellular network preferred**.

Make a Wi-Fi call

Make sure that  appears at the top of your screen.









1. In the Phone app, tap .
2. Enter the number.
3. Tap .

Wireless & networks





Connections

Wireless connection icons

The following icons might appear at the top of your screen to indicate the wireless coverage level that your device currently has.

Icon	Description
	The amount of solid color indicates the strength of the mobile signal. If the signal is weak, your device might use more power to try to maintain the connection.
LTE 4GLTE 4G 3G+ 3G 2G 1X H+ H G E	Your device is connected to the mobile network and can access all of the features of your mobile network plan.
lte 4glte 4g 3g+ 3g 2g 1x h+ h g e	Your device is connected to the network type shown, but the network functionality is limited. You might be able to make a phone call, but you might not be able to access the Internet or view email messages.
	You have no mobile network coverage. You can only make emergency calls.
R	Your device is roaming. Extra charges might apply.
	The amount of solid color indicates the strength of the Wi-Fi signal. If the signal is weak, your device might use more power to maintain the connection.
	Your device is connected to a Wi-Fi network but there is no Internet connectivity. Your device uses the mobile network instead.
	Wi-Fi is turned off on your device.
	Your device is connected to a VPN.
	Your device is in airplane mode and all of your wireless network connections are turned off. You can turn on Wi-Fi or Bluetooth technology, but not your connection to the mobile network.
	There is no SIM card in your device.

The following icons appear at the top of your screen if your device is connected or trying to connect to another device using mobile hotspot mode, Internet tethering, Bluetooth technology, a USB cable, or NFC.

Icon	Description
	Mobile hotspot mode is turned on.
	Bluetooth technology is turned on. If this icon is inside a box, your device is connected to another device using Bluetooth tethering.
	Your device is connected to another device using a USB cable. If this icon is inside a box, your device is connected to another device using USB tethering.
	NFC is turned on.

Turn on airplane mode

When you turn on airplane mode, all of the connections on your device turn off.

1. Swipe down from the top of the screen once using two fingers, or twice using one finger.
2. Tap  > **More**.
3. Turn on the **Airplane mode** switch.

After you turn on airplane mode, you can turn on certain connections, such as Wi-Fi or Bluetooth technology. This feature allows you to connect to a Wi-Fi network on an airplane, for example.

Mobile network

A mobile network connection allows your device to make calls and, if you have a data plan, use data services such as Internet browsing.

If your device is set up for roaming and you travel outside of your service provider's wireless coverage area, in most cases, your device connects to another service provider's wireless network automatically. If you're not sure whether your device is set up for roaming, or what roaming fees apply, check with your service provider before you travel.

Connect to the mobile network

To connect to the mobile network, airplane mode must be turned off.

Your device is designed to connect automatically to your service provider's mobile network after you insert your SIM card into your device. If your device doesn't connect automatically, you can manually select the mobile network.

1. Insert your SIM card into your device.
2. If necessary, swipe down from the top of the screen once using two fingers, or twice using one finger.

3. Tap  > **More** > **Cellular networks** > **Network operators**.
4. Tap a network.

To turn off your mobile network connection, turn on airplane mode.

Set a preferred network type

1. Swipe down from the top of the screen once using two fingers, or twice using one finger.
2. Tap  > **More** > **Cellular networks** > **Preferred network type**.
3. Tap the type of network you prefer.

Switch mobile networks manually

If you can't connect to a mobile network or if the network signal is weak, you can try switching networks manually.

1. Swipe down from the top of the screen once using two fingers, or twice using one finger.
2. Tap  > **More** > **Cellular networks** > **Network operators**.
3. Tap a network.

Turn off data services over the mobile network

To turn off data services, you must have a SIM card in your device.

If you turn off data services, your device can't send or receive data over the mobile network and many features and apps might not work correctly.

1. Swipe down from the top of the screen once using two fingers, or twice using one finger.
2. Tap  > **Data usage**.
3. If necessary, tap the **Cellular** tab.
4. Turn off the **Cellular data** switch.

To turn on data services, turn on the **Cellular data** switch.

Turn off data services while roaming



Depending on your wireless service plan, you might be able to turn off data services (email messages, PIN messages, text messages with attachments, and browser service) on your device so that only the phone and basic text messaging are available. Turning off data services while roaming might prevent you from receiving additional roaming charges. For more information, contact your service provider.

1. Swipe down from the top of the screen once using two fingers, or twice using one finger.

2. Tap  > **More** > **Cellular networks**.
3. Tap **Data services while roaming**.
4. Do one of the following:
 - To turn off data services, tap **Off**.
 - To receive a prompt before using data services while roaming, tap **Prompt**.

Change the APN settings for your default Internet connection

Your device uses Access Point Name (APN) settings to open a data connection with your service provider's wireless network. You might need to change your APN settings if you change your wireless service plan or if the default settings don't apply to your service provider. Depending on your service provider, you might not be able to change the APN settings.

1. Swipe down from the top of the screen once using two fingers, or twice using one finger.
2. Tap  > **More** > **Cellular networks** > **Access Point Names**.
3. Do one of the following:
 - To create a new APN, tap .
 - To change an existing APN, tap an APN.
4. Complete the fields. If you don't have the required information, contact your service provider.
5. Tap  > **Save**.

To reset the default APN settings, tap  > **Reset to default**.

Change your wireless service plan

To change your wireless service plan, you must have a SIM card in your device.

Depending on your service provider, you might not be able to change the details of your wireless service plan from your device.

1. Swipe down from the top of the screen once using two fingers, or twice using one finger.
2. Tap  > **More** > **Mobile plan**.
3. Complete the instructions on the screen.

Troubleshooting: Mobile network

I can't connect to the mobile network

Try the following:

- Check that airplane mode is turned off. Swipe down from the top of the screen once using two fingers, or twice using one finger. Tap  > **More**. Check that the **Airplane mode** switch is turned off.
- Try switching to another mobile network. [Learn how to switch mobile networks manually](#).
- Check that the SIM card is inserted correctly in your device. [Learn how to insert the SIM card](#).



Wi-Fi network

A Wi-Fi network connection allows your device to use data services, but unlike using the mobile network, using Wi-Fi doesn't add charges to your data plan.

When you connect to a Wi-Fi network, your device saves the network information. The next time your device is within range of the saved Wi-Fi network, and Wi-Fi is turned on, your device can connect to the network automatically.



Your device can be connected to the mobile network and a Wi-Fi network at the same time. For basic data functions, such as using the Internet or downloading apps, your device is designed to try to use a saved Wi-Fi network before it tries to use the mobile network. Keep in mind that if you leave Wi-Fi turned on, your battery might lose power more quickly.

Connect to a Wi-Fi network

1. Swipe down from the top of the screen once using two fingers, or twice using one finger.
2. Tap  > **Wi-Fi**.
3. If necessary, turn on the switch.
4. Tap a network.
5. If necessary, do one of the following:
 - Enter the password for the Wi-Fi network, and then tap **Connect**.
 - To connect to a Wi-Fi network at work, enter your username and password, and then tap **Connect**.
 - To connect to a public network, tap the sign-in notification and, if necessary, accept the license agreement. If necessary, tap  > **Use this network as is**.

Add a Wi-Fi network manually

If your device doesn't connect automatically to a saved Wi-Fi network, you can set up a connection to a Wi-Fi network manually. If you don't have the required information, ask your network administrator or the person who manages the Wi-Fi network.

1. Swipe down from the top of the screen once using two fingers, or twice using one finger.
2. Tap  > **Wi-Fi**.
3. If necessary, turn on the switch.
4. Tap  > **Add network**.
5. In the **Network** field, type the SSID for the network.

6. In the **Security** drop-down list, tap the network's security type.
7. If necessary, tap **Advanced options** and specify additional information.
8. Tap **Save**.

Connect to a Wi-Fi network using a proxy

You can connect to any Wi-Fi network using a proxy. You must be within range of the Wi-Fi network to change the proxy settings.

1. Swipe down from the top of the screen once using two fingers, or twice using one finger.
2. Tap  > **Wi-Fi**.
3. If necessary, turn on the switch.
4. Touch and hold a network.
5. Tap **Modify network**.
6. Tap **Advanced options**. You might need to slide your finger up to see this option.
7. In the **Proxy** drop-down list, do one of the following:
 - To set up a proxy, tap **Manual**, and then enter the proxy settings.
 - To use a proxy already set up for the network, tap **Proxy Auto-Config**, and then confirm the proxy settings.
8. Tap **Save**.

Delete a saved Wi-Fi network

If you don't want your device to connect to a Wi-Fi network automatically, you can delete the information used to connect to the network.

1. Swipe down from the top of the screen once using two fingers, or twice using one finger.
2. Tap  > **Wi-Fi**.
3. If necessary, turn on the switch.
4. Tap a network, and then tap **Forget**.

Share your Wi-Fi connection information using NFC

Make sure that NFC is turned on.

You can allow others to connect to a password-protected Wi-Fi network with a simple tap of a device. For example, you might want to let guests use your home Wi-Fi network when they visit.

If the Wi-Fi network requires a username and password, for example, a Wi-Fi network at work, you can't share your Wi-Fi connection information using NFC.

1. Swipe down from the top of the screen once using two fingers, or twice using one finger.
2. Tap  > **Wi-Fi**.

3. If necessary, turn on the switch.
4. Touch and hold a network name.
5. Tap **Share using NFC**.
6. Complete the instructions on the screen.

Set a static IP address for a Wi-Fi connection



You must be within range of your Wi-Fi network to change the IP settings.

By default, when you connect your device to a Wi-Fi network, your device assigns an IP address to the connection. You can set a static IP address that doesn't change each time you connect to a Wi-Fi network.

1. Swipe down from the top of the screen once using two fingers, or twice using one finger.
2. Tap  > **Wi-Fi**.
3. If necessary, turn on the switch.
4. Touch and hold a network.
5. Tap **Modify network**.
6. Tap **Advanced options**. You might need to slide your finger up to see this option.
7. In the **IP settings** drop-down list, tap **Static**.
8. Change the IP address fields.
9. Tap **Save**.

Change advanced settings for your Wi-Fi connections

You can change advanced settings for your Wi-Fi connections. For example, you can set whether your Wi-Fi connection remains active when your device sleeps and you can change the Wi-Fi frequency band. You can also find the Media Access Control (MAC) address and IP address for your device.

1. Swipe down from the top of the screen once using two fingers, or twice using one finger.
2. Tap  > **Wi-Fi**.
3. If necessary, turn on the switch.
4. Tap  > **Advanced**.

Advanced Wi-Fi connection settings



Setting	Description
Network notification	Turn on this switch to receive a notification when your device is within range of a public Wi-Fi network.

Setting	Description
Keep Wi-Fi on during sleep	Tap this option to choose whether your device remains connected to the Wi-Fi network when your device sleeps. If you turn off your Wi-Fi connection when your device sleeps, you might increase the amount of mobile data you use.
Wi-Fi frequency band	Tap to set the frequency band. When you set the band to 5 GHz, your device connects to access points on the 5-GHz band only. When set to 2.4 GHz, your device connects to access points on the 2.4-GHz band only. When set to automatic, your device tries to connect to the band with the stronger signal strength.
Install certificates	Tap this option to install digital certificates that can identify your device when, for example, your device connects to VPN or a Wi-Fi network.
Wi-Fi Direct	Tap this option to connect with available Wi-Fi Direct compatible devices.
WPS Push Button	Tap this option to turn on the Wi-Fi Protected Setup feature.
WPS PIN Entry	Tap this option to enter the PIN for the Wi-Fi Protected Setup feature.

Troubleshooting: Wi-Fi connections

I can't connect to a Wi-Fi network

Start by checking the following:

- Verify that Wi-Fi is turned on. Swipe down from the top of the screen once using two fingers, or twice using one finger. Tap  > **Wi-Fi**. Check that the switch is turned on.
- Try turning airplane mode on and off. [Learn how to turn on airplane mode.](#)
- Check that your password for the Wi-Fi network is correct.
- Turn off your device, and then turn it on again.
- Delete the information used to connect to the Wi-Fi network, and then try to connect again. [Learn how to delete a saved Wi-Fi network.](#)
- Verify that mobile hotspot mode is turned off. If mobile hotspot mode is on, your device can't connect to a Wi-Fi network. Swipe down from the top of the screen once using two fingers, or twice using one finger. Tap  > **More** > **Tethering & Mobile Hotspot**. Check that the **Mobile Hotspot** switch is turned off.
- Unplug your modem or router for 15 seconds, and then plug it in again.
- Try connecting your device to another Wi-Fi network at another location. If you can connect to another Wi-Fi network, the problem might be specific to the Wi-Fi network at the original location.

Try more advanced troubleshooting options:

- Try choosing a different authentication type. Swipe down from the top of the screen once using two fingers, or twice using one finger. Tap  > **Wi-Fi**. Touch and hold the Wi-Fi network, and then tap **Modify network**. Tap **EAP method**, and then tap a different authentication type.

- Check that the time on your device is correct and synchronized with the network time. If the times are different, it could prevent your device from connecting (for example, connecting to a network might require that you have a certificate on your device, and the certificate has an expiration date).
- If you use your device for work, your organization might prevent connections to certain wireless access points. For more information, contact your administrator.

If you still can't connect, contact your Internet service provider.

Bluetooth technology

Bluetooth wireless technology allows you to create a direct connection between your device and another Bluetooth enabled device. For example, you can use a Bluetooth connection to play music through a separate speaker, make calls on a headset, share files, or connect to Android Wear™ or a car kit.

Before you can connect to a Bluetooth enabled device, you must turn on Bluetooth technology on your device and then pair the two devices. Some paired devices, for example, a car kit, usually connect to your device automatically.

Turn on Bluetooth technology

If you turn on Bluetooth technology, your device is discoverable and visible to other Bluetooth enabled devices nearby.

1. Swipe down from the top of the screen once using two fingers, or twice using one finger.
2. Tap  > **Bluetooth**.
3. Turn on the switch.

To turn off Bluetooth technology, turn off the switch.

Pair and connect your device with a Bluetooth enabled device



Make sure that you turn on Bluetooth technology on the device that you want to connect to.

1. Swipe down from the top of the screen once using two fingers, or twice using one finger.
2. Tap  > **Bluetooth**.
3. If necessary, turn on the switch.
4. To pair the devices, in the **Available devices** list, tap the device name, and complete the instructions on the screen. If you're prompted to enter a pairing code, try entering 0000 or 1234, or check the documentation that came with the device.
5. To connect the devices, in the **Paired devices** list, tap the device name.

Your devices are ready to communicate over the Bluetooth connection.



Change the name of your device for Bluetooth connections

If you turn on Bluetooth technology, the name of your device is visible to other Bluetooth enabled devices nearby.

1. Swipe down from the top of the screen once using two fingers, or twice using one finger.
2. Tap  > **Bluetooth**.
3. If necessary, turn on the switch.
4. Tap  > **Rename this device**.
5. Enter a new name for your device.
6. Tap **Rename**.



Change the settings for a paired Bluetooth enabled device

Some Bluetooth enabled devices support more than one Bluetooth feature. You can turn a feature on or off for a paired Bluetooth enabled device. You can also change the name of a paired device as it appears on your device.



1. Swipe down from the top of the screen once using two fingers, or twice using one finger.
2. Tap  > **Bluetooth**.
3. Tap  beside the device you want to change.
4. Make your changes.
5. Tap **OK**.

Delete a paired Bluetooth enabled device

If you no longer want to connect to a Bluetooth enabled device, you can delete the device from the list of paired devices.



1. Swipe down from the top of the screen once using two fingers, or twice using one finger.
2. Tap  > **Bluetooth**.
3. Tap  beside the device you want to disconnect.
4. Tap **Forget**.

View a list of files you received over Bluetooth

1. Swipe down from the top of the screen once using two fingers, or twice using one finger.
2. Tap  > **Bluetooth**.
3. If necessary, turn on the switch.
4. Tap  > **Show received files**.

Change the accounts that Bluetooth enabled devices can access

If another Bluetooth enabled device, such as a car kit or watch, supports the Message Access Profile (MAP), the device can access your text messages (SMS and MMS) and email messages when it's connected to your device.

1. Swipe down from the top of the screen once using two fingers, or twice using one finger.
2. Tap  > **Bluetooth**.
3. If necessary, turn on the switch.
4. Tap  > **Advanced**.
5. Turn off any of the switches.

About using Google Voice Search™ when connected to a car kit

If your device is connected to a Bluetooth enabled car kit, you can use Google Voice Search™. Google Voice Search™ lets you search for information on your device or over the Internet, and also allows you to update information on your device hands-free. For example, you can check the weather, search for a restaurant, or create an appointment.

To use Google Voice Search™ when your device is connected to a car kit, you must set up Bluetooth technology for Google Voice Search™. Your device must be paired with and connected to the car kit, and your contacts must be synced with the car kit.

For information on how to use the car kit, see the documentation that came with the vehicle.

Turn on Bluetooth technology for Google Voice Search™

To use Google Voice Search™ when your device is connected to a Bluetooth enabled car kit, you must turn on the Bluetooth headset switch in the Google Voice Search™ settings. This setting lets you record and hear audio through your connected Bluetooth enabled device.

1. Swipe down from the top of the screen once using two fingers, or twice using one finger.
2. Tap  > **Google** > **Search & Now** > **Voice**.
3. Turn on the **Bluetooth headset** switch.

Use Google Voice Search™ from a car kit

Your contacts must be synced with the car kit.

When your device is connected to a car kit using Bluetooth technology, Google Voice Search™ responds to your request using audio through your car speakers. If Google Voice Search™ can't find a response for your request, it displays search results on your device.

1. From your car kit, search your contacts for **#VoiceSearch**.
2. From your car kit, call **#VoiceSearch**.
3. Say your question or other request.

Supported Bluetooth profiles

Your device is a Bluetooth Smart Ready device, and supports the following profiles.

Profile	Description
Advanced Audio Distribution Profile (A2DP)	This profile allows your device to stream audio files to Bluetooth enabled devices that support stereo audio, such as stereo headsets, speakers, and car kits.
Audio/Video Remote Control Profile (AVRCP)	This profile allows you to use the buttons on a Bluetooth enabled device, such as a headset, to perform actions such as adjusting the volume or playing the next or previous media file on your device. This profile also displays information about songs on a Bluetooth enabled device.
Device Identification Profile (DID)	This profile allows Bluetooth enabled devices to access information about your device model to support plug and play features, such as automatically downloading the required drivers.
Hands-Free Profile (HFP)	This profile allows you to connect your device to Bluetooth enabled headsets and car kits to make hands-free calls. This profile supports wideband audio.
Headset Profile (HSP)	This profile allows you to connect your device to a Bluetooth enabled headset.
Human Interface Device Profile (HID)	This profile allows you to connect your device to a Bluetooth enabled device, such as a keyboard or mouse.
Human Interface Device over Gatt Profile (HOGP)	This profile allows you to connect your device to a Bluetooth Smart device, such as a keyboard or mouse.
Message Access Profile (MAP)	This profile allows a car kit to access messages on your device and lets you browse and read the messages. If supported by the car kit, you can also delete, compose, and send messages from your car.
Object Push Profile (OPP)	This profile allows your device to send files to and receive files from a Bluetooth enabled device.
Personal Area Network Profile (PAN)	This profile allows you to use your device to share your network connection when connected to a Bluetooth enabled computer. This profile also lets you connect your device to another device that is sharing its network connection.
Phone Book Access Profile (PBAP)	This profile allows a Bluetooth enabled car kit to access contact information and recent call history information on your device. This profile allows the car kit to display the contact name for an incoming call.
Serial Port Profile (SPP)	This profile allows you to connect your device to other Bluetooth enabled devices that support the Serial Port Profile for data transfer.

Profile	Description
Remote SIM Access Profile (rSAP)	This profile allows a Bluetooth enabled device, such as a car kit, to access the SIM card on your device.

Troubleshooting: Bluetooth connections

I can't pair my device with a Bluetooth enabled device

- Check that your device and the device that you want to connect to have Bluetooth technology turned on.
- To scan again for nearby Bluetooth enabled devices, on the **Bluetooth** screen, tap  > **Refresh**.
- If your Bluetooth enabled device requires a passkey and you don't know what the passkey is, try 0000 or 1234, or check the documentation that came with your Bluetooth enabled device.
- If the Bluetooth enabled device uses a battery, connect the device to a power source and then try again. If the battery power level is too low, the device might be unable to pair with another device.
- Check that your device is compatible with the Bluetooth enabled device. For more information, see the documentation that came with the Bluetooth enabled device.
- If mobile hotspot mode is turned on, verify that the device that you want to connect to uses the Hands-Free, Serial Port, or Personal Area Network profile.

I keep losing the connection with my Bluetooth enabled car kit

- Check that your car kit is using the latest software version. For more information about your car kit's software version, see the documentation that came with your car kit.
- Move your device to another location in your vehicle or turn your device to face another direction. The location of your device's antenna in relation to your car kit's Bluetooth antenna may affect the Bluetooth connection.

I can't hear Google Voice Search™ audio on my Bluetooth enabled device

Try any of the following:

- By default, Google Voice Search™ uses the speaker and microphone on your BlackBerry device instead of the speaker and microphone on your Bluetooth enabled device. To hear audio through your connected Bluetooth enabled device, swipe down from the top of the screen once using two fingers, or twice using one finger. Tap  > **Google** > **Search & Now** > **Voice**. Turn on the **Bluetooth headset** switch.
- Turn up the volume on the Bluetooth enabled device.

NFC

NFC is a short-range wireless technology that you can use to share content and information with another NFC-enabled device or an NFC tag. Some NFC apps are designed to simulate a physical card, such as a credit card, a public transit pass,

or an access badge. With NFC, you don't enter any information to create a connection, making NFC useful for on-the-go actions.

If an app supports NFC, you might be able to:

- Share a picture with a friend.
- Unlock your device using the Smart Lock feature.
- Grab a coupon from a poster.
- Send a webpage to a friend.
- Exchange contact cards with a business acquaintance.

Share content using NFC

To share content with another device, make sure that both devices are unlocked and support NFC.

In some cases, you might need to tap a specific part of your device against the other device or tag. To see where your device's NFC signal is strongest, see [Your device at a glance](#).

Not all apps support NFC.

1. On your device, open a screen that shows what you want to share, such as a webpage, YouTube video, or contact.
2. Tap the back of your device against the back of another NFC-enabled device or an NFC tag.
3. To send a file, if necessary, touch your device screen.
When the devices connect, you might hear a sound or your device might vibrate.

Tip: If you can't share content, try using the Android™ Beam feature. Open a screen that shows what you want to share. Tap  > **Share** > **Android Beam**. Complete the instructions on the screen.

Change the NFC settings

1. Swipe down from the top of the screen once using two fingers, or twice using one finger.
2. Tap  > **More** > **NFC**.
3. If necessary, turn on the **NFC** switch.
4. Do any of the following:
 - To accept file transfers automatically, turn off the **Prompt before receiving** switch.
 - To allow transactions when the backlight is off, turn on the **Allow when screen is off** switch.
 - To allow transactions when your device is turned off, make sure that the **Allow when screen is off** switch is turned on. Turn on the **Allow when device power is off** switch.
 - To turn off the Android™ Beam feature, turn off the **Android Beam** switch.

To turn off NFC, turn off the **NFC** switch.

About tap & pay

When NFC is turned on, you can tap the back of your device to an NFC payment terminal to pay for your purchase.

If you have more than one payment app installed on your device, when you tap to pay for a purchase, you pay using the app that is set as the default. You can change which app is used as the default. If you want to use another payment app for some transactions, you can set the tap and pay feature to use the payment app that is open in the foreground instead.

Change the payment settings for tap & pay

Make sure that NFC is turned on.

1. Swipe down from the top of the screen once using two fingers, or twice using one finger.
2. Tap  > **Tap & pay**.
3. To change the default app, tap **Payment default**. Tap an app, and then tap **OK**.
4. To use other payment apps for some transactions, tap **Use default** > **Except when another payment app is open**.

Tethering and mobile hotspot mode

Internet tethering

Internet tethering allows another device, such as a laptop or tablet, to share your device's connection to the mobile network. You can connect the other device to your BlackBerry device using a USB cable or, if both devices are Bluetooth enabled, you can use Bluetooth technology instead.

Additional charges might apply for using Internet tethering.

Mobile hotspot

When you use the mobile hotspot feature, your device becomes a wireless access point for other Wi-Fi enabled devices to connect to and access the Internet. For the best performance, plug your device into a battery charger and connect it to a power source.

Since the mobile hotspot feature uses the mobile network, you might incur additional data charges.

Use Internet tethering to share your mobile network connection

If your device has a data plan, you can share its Internet connection with another device, such as a laptop or tablet. You can tether your devices using an appropriate cable or a Bluetooth connection.

1. Swipe down from the top of the screen once using two fingers, or twice using one finger.

2. Tap  > **More** > **Tethering & Mobile Hotspot**.
3. Do one of the following:
 - Connect your device to another device using an appropriate cable, and then turn on the **USB tethering** switch.
 - Turn on the **Bluetooth tethering** switch, and then connect your device to another device using Bluetooth technology.

To stop sharing your Internet connection, turn off the **USB tethering** or **Bluetooth tethering** switch.

Use mobile hotspot to share your Internet connection

Before you turn on mobile hotspot, confirm that your device is connected to the mobile network.

When you set up your mobile hotspot, record the name of your mobile hotspot and the password. You, or the user of another device that wants to connect to your mobile hotspot, must know the name of your mobile hotspot and the password to connect.

1. Swipe down from the top of the screen once using two fingers, or twice using one finger.
2. Tap  > **More** > **Tethering & Mobile Hotspot**.
3. Turn on the **Mobile Hotspot** switch.
4. To change your settings, tap **Set up Mobile Hotspot**. Make your changes, and then tap **Save**.

To stop sharing your Internet connection, turn off the **Mobile Hotspot** switch.



View a list of devices that are connected to your mobile hotspot

Make sure that mobile hotspot is turned on.

1. Swipe down from the top of the screen once using two fingers, or twice using one finger.
2. Tap  > **More** > **Tethering & Mobile Hotspot** > **Connected devices**.

Troubleshooting: Tethering and mobile hotspot

I can't use Internet tethering

- Check that your device is connected to the mobile network.
- Check that data services are turned on. Swipe down from the top of the screen once using two fingers, or twice using one finger. Tap  > **Data usage**. Confirm that the **Cellular data** switch is turned on.
- Check that your wireless service plan is set up to use Internet tethering.
- If your wireless service plan supports Internet tethering while roaming, check that data roaming is turned on. Swipe down from the top of the screen once using two fingers, or twice using one finger. Tap  > **More** > **Cellular networks**. Confirm that the **Data services while roaming** setting is set to **Prompt** or **On**.

- If you use your device for work, your organization might not allow Internet tethering. For more information, check with your administrator.

I can't use my device as a mobile hotspot

- Check that you're connected to the mobile network.
- Check that your wireless service plan is set up to use the mobile hotspot feature. If not, you must change your wireless service plan before mobile hotspot can work on your device.
- Your service provider might not allow the use of the mobile hotspot feature while roaming. For more information, check your wireless service plan or contact your service provider.
- If you're using your device for work, your organization might not allow the use of the mobile hotspot feature. For more information, check with your administrator.

I can't find the mobile hotspot password

If you set up a mobile hotspot, you must enter the mobile hotspot password on the device that is trying to connect to your mobile hotspot.

To find your password, on your BlackBerry device, swipe down from the top of the screen once using two fingers, or twice using one finger. Tap  > **More** > **Tethering & Mobile Hotspot**, and then tap **Set up Mobile Hotspot**. Tap the **Show password** checkbox.



VPN

A connection to a virtual private network (VPN) allows your device to use a wireless network connection to send data to and receive data from a private network. For example, a VPN connection allows your device to connect securely to your organization's network when you are working outside the office. When you connect to a VPN, the security and data management policies for the private network protect your data.

Before you can connect to a VPN, you must add a VPN profile. Only the device owner can add and manage VPN profiles on your device. You might also need to install a VPN app on your device. For more information, contact your administrator or download a VPN app from the Google Play™ store.

Add a VPN profile

Before you can add a VPN profile, you must set a screen lock for your device.

1. Swipe down from the top of the screen once using two fingers, or twice using one finger.
2. Tap  > **More** > **VPN** > .
3. Complete the fields on the screen. If you don't know the network information, contact your administrator.
4. Tap **Save**.

Connect to a VPN



You must add a virtual private network (VPN) profile to your device before you can connect to a VPN.

1. Swipe down from the top of the screen once using two fingers, or twice using one finger.
2. Tap  > **More** > **VPN**.
3. Tap a VPN profile.
4. Enter your login information, and then tap the **Save account information** checkbox to connect automatically next time.
5. Tap **Connect**.

To disconnect from a VPN, on the **VPN** screen, tap the VPN profile you are connected to. Tap **Disconnect**.



Connect to a VPN automatically

To connect to a VPN automatically, the VPN must support always-on mode.

1. Swipe down from the top of the screen once using two fingers, or twice using one finger.
2. Tap  > **More** > **VPN**.
3. Tap  > **Always-on VPN**.
4. Complete the instructions on the screen.

To turn off always-on mode, on the **VPN** screen, tap  > **Always-on VPN** > **None** > **OK**.

Change or delete a VPN profile

1. Swipe down from the top of the screen once using two fingers, or twice using one finger.
2. Tap  > **More** > **VPN**.
3. Tap  beside the VPN profile you want to change or delete.
4. Do one of the following:
 - Change the information, and then tap **Save**.
 - Tap **Forget**.

Emergency broadcast messages

Depending on your region, service provider, and wireless network, you might receive text messages (SMS or MMS) about possible threats to safety in your area. For example, you might receive messages with information about severe weather, a missing child, or a national emergency. For more information, contact your service provider or administrator.

Change the settings for emergency broadcast messages

Depending on your region, some settings might not be available.

1. Swipe down from the top of the screen once using two fingers, or twice using one finger.
2. Tap  > **More** > **Emergency broadcasts**.
3. Do any of the following:
 - To receive a reminder for emergency broadcast messages, tap **Alert reminder**, and then tap how often you want to receive a reminder.
 - To stop your device from vibrating when you receive an emergency broadcast message, clear the **Vibrate** checkbox.
 - To turn off the text-to-speech feature, clear the **Speak alert message** checkbox.
 - To stop receiving emergency broadcast messages, clear the **Show extreme threats**, **Show severe threats**, and **Show AMBER alerts** checkboxes.



Data usage

Data usage refers to the amount of data that your device uploads and downloads when it is connected to the wireless network. If you share your device with others, you can monitor the amount of data used by the device owner, guest, and any user profiles on the device. Only the device owner can change the data usage settings.

If you exceed the data limit of your plan, your service provider might charge you additional fees. For more information about your data limit, check your wireless service plan.

Monitor your wireless data usage

You can check how much data you use by wireless network type, time period, app, or in total.

1. Swipe down from the top of the screen once using two fingers, or twice using one finger.
2. Tap  > **Data usage**.
3. To see your Wi-Fi usage, tap  > **Show Wi-Fi**. Tap the **Wi-Fi** tab near the top of the screen.
4. Do any of the following:
 - To check how much data you used during the current data usage cycle, view the value beside the time period.
 - To check how much data an app used, view the value beside the app name.
 - To check how much data each user profile set up on the device used, tap a user profile.
 - To check how much data you used during a different time period, beside the current time period, tap  > **Change cycle**. Tap a date, and then tap **Set**.

Tip: You can close some apps to help reduce your data usage.

Change when you get notified about data usage

Your wireless service plan must include data services.

1. Swipe down from the top of the screen once using two fingers, or twice using one finger.
2. Tap  > **Data usage**.
3. If necessary, tap the **Cellular** tab, and turn on the **Cellular data** switch.
4. At the top of the graph, drag the warning line up or down.



Set a limit for data usage

You can set a limit on the amount of data that your device can use when it's connected to the mobile network. If your device reaches that limit, it can turn off data services and send you a notification. When data services are turned off, apps and services on your device might not work correctly.

1. Swipe down from the top of the screen once using two fingers, or twice using one finger.
2. Tap  > **Data usage**.
3. If necessary, tap the **Cellular** tab, and turn on the **Cellular data** switch.
4. Turn on the **Set cellular data limit** switch, and then tap **OK**.
5. At the top of the graph, drag the red line up or down.



Stop sending background data over the mobile network

To reduce the amount of data that your device uses when connected to the mobile network, you can stop apps and services from sending data when you aren't actively using the app or service. If you restrict background data, apps and services might not work correctly unless your device connects to a Wi-Fi network.

1. Swipe down from the top of the screen once using two fingers, or twice using one finger.
2. Tap  > **Data usage**.
3. If necessary, tap the **Cellular** tab, and turn on the **Cellular data** switch.
4. Do one of the following:
 - To turn off background data for all apps and services on your device, tap  > **Restrict background data**, and then tap **OK**.
 - To turn off background data for an app or a service, tap the app or service. Turn on the **Restrict app background data** switch, and then tap **OK**.

Stop sending data on some Wi-Fi networks

You can stop apps and services from sending data in the background, and prevent your device from downloading large files when it's connected to certain Wi-Fi networks.

1. Swipe down from the top of the screen once using two fingers, or twice using one finger.
2. Tap  > **Data usage** >  > **Network restrictions**.
3. Tap a network name.

Settings

Change your device settings

1. Swipe down from the top of the screen once using two fingers, or twice using one finger.
2. Tap a setting or, to see more settings, tap .

Tip: To find a setting quickly, tap , and then type the setting that you're looking for.

Display

Change your wallpaper

Add your favorite photo to the home screen of your device.

1. In the Photos app, tap a picture.
2. Tap  > **Use as**. If necessary, tap **More**.
3. Tap **Wallpaper**.
4. Slide your fingers apart or together to zoom in or zoom out.
5. Tap **Set wallpaper**.

Tip: To change your wallpaper, touch and hold a blank area on a home screen. Tap **Wallpapers**. Tap a wallpaper or a Live Wallpaper. To use a picture as your wallpaper, tap **Select image** and tap a picture.

Take a screenshot

Press and hold the **Volume down** key and the **Power on/off** key at the same time.

To find your screenshot, in the Photos app, tap  > **Device folders**. Screenshots are saved in the **Screenshots** folder.

Change the screen brightness

1. Swipe down from the top of the screen once using two fingers, or twice using one finger.
2. Drag  to the left or right.

Change your font size

1. Swipe down from the top of the screen once using two fingers, or twice using one finger.
2. Tap  > **Display** > **Font size**.
3. Tap the text size that you want to use.

Change your display language

The language that you selected during the initial setup of your device is your display language. The home screen, BlackBerry Hub, and supported applications display content in this language.

1. Swipe down from the top of the screen once using two fingers, or twice using one finger.
2. Tap  > **Language & input** > **Language**.
3. Tap a language.



Change how you view your recent apps and screens

When you tap , you see a tiled view, a masonry view, or a rolodex view of your recent apps and screens. You can change the view to suit your preferences.

1. Swipe down from the top of the screen once using two fingers, or twice using one finger.
2. Tap  > **Display** > **Recents**.
3. Select a view.
4. Tap **Done**.

Turn on or turn off screen rotation

Choose whether or not your screen rotates when you turn your device.

1. Swipe down from the top of the screen once using two fingers, or twice using one finger.
2. Tap  or .

Note: If you don't see the rotation icons, tap  > **Accessibility** and turn on the **Auto-rotate screen** switch.

Set up Daydream™

With Daydream™, you can display your photos, apps, and more as screensavers while your device is idle or charging. You can customize what to display and when.

1. Swipe down from the top of the screen once using two fingers, or twice using one finger.
2. Tap  > **Display** > **Daydream**.
3. Turn on the switch.

Choose what to display in Daydream™

After you turn on the Daydream™ feature, you can select which dreams you want to display, such as the clock or pictures, when your device is sleeping.

1. On the Daydream™ screen, tap a dream.
2. If necessary, tap  beside a dream to see even more customization options.

Your dreams display the next time your device goes to sleep. To show dreams right away, tap  > **Start now**.

To download or buy more dreams from the app store, tap  > **Install More Dreams**.

Set when to Daydream™

When the Daydream™ feature is on, you can set when dreams display on your device.

1. On the Daydream™ screen, tap  > **When to daydream**.
2. Tap **While docked**, **While charging**, or **Either**.

Set the wait time for sleep mode

Set the length of time that your device remains inactive before entering sleep mode and before your Daydream starts.



1. Swipe down from the top of the screen once using two fingers, or twice using one finger.
2. Tap  > **Display** > **Sleep**.
3. Tap a time.

Cast your screen

Using Chromecast™ or a Wi-Fi CERTIFIED Miracast device, you can display your device's screen onto your TV. With Chromecast™, you can also display content like TV shows, movies, photos, games, and websites from supported apps.

[Learn more about Chromecast.](#)

[Learn more about Wi-Fi CERTIFIED Miracast.](#)

1. Swipe down from the top of the screen once using two fingers, or twice using one finger.
2. Tap  > **Display** > **Cast**.
3. If necessary, tap  and select the **Enable wireless display** checkbox.
4. Tap the device that you want to share your screen on.

Tip: After you set up devices that you want to share your screen on, you can access them in the Quick Settings menu by tapping .

To stop casting your screen, swipe down from the top of the screen once with two fingers or twice with one finger. Tap , then tap the device you're casting to and tap **Disconnect**.

Use your device as a flashlight

1. Swipe down from the top of the screen once using two fingers, or twice using one finger.
2. Tap .

To turn off the flashlight, tap .

Notifications

Manage your notifications

Notifications let you know about new messages, calendar events, app updates, and more. When you receive a notification, an indicator appears in the upper-left corner of the screen.

Check and open your latest notifications

1. Swipe down from the top of the screen with one finger.
2. If necessary, pull down to see more notifications.
3. Tap a notification to open it.

Block or prioritize a notification

1. Swipe down from the top of the screen with one finger.

2. Touch and hold a notification.
3. Tap .
4. Turn on the **Block all** or **Treat as priority** switch.

Dismiss a notification

1. Swipe down from the top of the screen with one finger.
2. Swipe left or right on a notification.

Note: To dismiss all of your notifications at once, tap  or **Clear All**.

View notifications for a single app

1. Swipe down from the top of the screen with one finger.
2. Tap an app icon, such as BBM, BlackBerry Help, or Phone.

To exit the filtered view and return to the full notifications list, tap the app icon again.

Change the volume of your notifications

You can quickly access the volume sliders for notifications, media, and alarms when you press the "Volume up/down key" and then tap . You can also customize the volume from the device settings screen.

1. Swipe down from the top of the screen once using two fingers, or twice using one finger.
2. Tap  > **Sound & notification**.
3. Drag any of the sliders to the right or left.

Note: The  **Ring volume** slider adjusts the volume for both your ringtone and your notification sounds. If you want to control these volumes separately, you can find apps for that in the Google Play™ store.

Change your notification sounds

Note: To change notification sounds and vibration settings for a specific app, look in the Settings screen inside the app. For example, if you want to turn off notification sounds for new emails, open BlackBerry Hub, open the Settings screen, and change the notification settings for your email account.

Change the default notification sound

The default sound only applies to apps that are set to use the default.

1. Swipe down from the top of the screen once using two fingers, or twice using one finger.
2. Tap  > **Sound & notification** > **Default notification ringtone**.
3. Tap a notification sound.
4. Tap **OK**.

To turn sounds on or off for features such as screen locking or the dial pad, tap **Other sounds**. Turn any of the switches on or off.

Add a custom notification sound

Note: If your device uses Android for Work, you can't select custom notification sounds for apps inside your work space.

1. Save the .mp3 file you want to use to the **Notifications** folder in your device's internal storage.
2. When you set the notification sound in an app's settings or change the default notification sound, tap the file name of your .mp3 file.
3. Tap **OK**.

Turn off all sounds and notifications

Do not disturb lets you quickly silence your device when you don't want to be interrupted, like in a movie theater or during an important meeting. You can also choose to receive only certain notifications, like calls or alarms.

Turn on do not disturb

1. Swipe down from the top of the screen once using two fingers, or twice using one finger.
2. Tap .
3. Tap **Total silence**, **Alarms only**, or **Priority only**.
4. To change how long do not disturb stays on, tap + or -, or tap **Until you turn this off**.
5. Tap **Done**.

Tip: You can quickly turn on alarms only mode by pressing the **Volume down** key until the volume is all the way down, then pressing the key once more.

Keep some sounds and notifications on

You can use priority only mode to receive the notifications that are most important to you while keeping everything else silent.

1. Swipe down from the top of the screen once using two fingers, or twice using one finger.
2. Tap  > **Priority only** > **More settings** > **Priority only allows**.

3. Choose the types of notifications you want to keep on.

Turn off all sounds and notifications except calls

1. Swipe down from the top of the screen once using two fingers, or twice using one finger.
2. Tap  > **Priority only** > **More settings** > **Priority only allows**.
3. Turn off the **Reminders** and **Events** switches.
4. Tap **Messages** > **None**.
5. Tap **Calls** > **From anyone**.

Automatically turn on do not disturb at certain times

You can automatically turn on do not disturb at regular times or during all events of a certain type in your calendar.

1. Swipe down from the top of the screen once using two fingers, or twice using one finger.
2. Tap  > **Sound and notification** > **Do not disturb** > **Automatic rules**.
3. Tap one of the existing rules or add a new one.
4. If necessary, change the rule's settings.
5. If necessary, tap the switch at the top of the screen to turn on the rule.

Customize notifications for an app

To change notification sounds and vibration settings for a specific app, look in the Settings screen inside the app. For example, if you want to turn off notification sounds for new emails, open BlackBerry Hub, open the Settings screen, and change the notification settings for your email account.

To change system-level notification settings for individual apps, follow the steps below.

1. Swipe down from the top of the screen once using two fingers, or twice using one finger.
2. Tap  > **Sound & notification** > **App notifications**.
3. Tap an app.
4. Do one of the following:
 - To stop receiving notifications from the app, turn on the **Block all** switch.
 - To see notifications from the app at the top of your notifications list, and to receive priority notification interruptions, turn on the **Treat as priority** switch.
 - If available, to set a custom LED color for the app, turn on the **Customize LED Color** switch. Tap **LED Color** and then tap a color.
 - To stop seeing notifications slide onto the top of your screen, turn off the **Allow peeking** switch.

- To hide notification contents on the lock screen, turn on the **Hide sensitive content** switch. To see this switch, a screen lock option, such as a password, must be set and the option **When device is locked** on the **Sound & notification** screen must be set to **Show all notification content**.

You can grant some apps access to your notifications. Typically, these will be apps that present notifications to you in another context, like Android™ Auto or BlackBerry Hub. To see these apps, or to turn access on and off, tap  > **Sound & notification** > **Notification access**. Tap an app to turn access on or off.

Change how notifications are displayed on your lock screen

You can customize your settings so that only the notifications that you want to see show up on the screen when your device is locked.

Note: Settings that you choose for the lock screen override notifications settings for individual apps.

For information about setting a screen lock, see [Set up or change a screen lock](#).

1. Swipe down from the top of the screen once using two fingers, or twice using one finger.
2. Tap  > **Sound & notification** > **When device is locked**.
3. Do one of the following:
 - To get all notifications on the lock screen, including the contents of incoming email messages and chats, tap **Show all notification content**.
 - To receive a notification, but keep the contents hidden (such as who sent an email or the title of the song you downloaded), tap **Hide sensitive notification content**. (To see this option, a screen lock option, such as a password, must be set.)
 - To prevent notifications from appearing on the lock screen, tap **Don't show notifications at all**.

Add owner info to your lock screen

You can add your name, a personal message, or any other information that displays on your device when the screen is locked.

1. Swipe down from the top of the screen once using two fingers, or twice using one finger.
2. Tap  > **Security** > **Lock screen message**.
3. Type your name or the message you want to display on the lock screen and tap **Save**.

BlackBerry Productivity Tab

The BlackBerry Productivity Tab provides quick access to your upcoming events, new messages, tasks, and contacts. The tab is available on all device screens.

By default, the tab is turned on and is centered on the right edge of the device screen. If you want to turn off the tab, swipe down from the top of the screen once using two fingers, or twice using one finger. Tap  > **Display**, and then turn off the **Productivity Tab** switch.

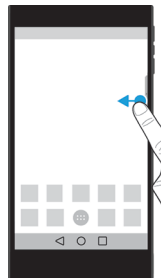



View productivity information and open apps

1. Swipe on the tab toward the center of the screen.
2. Tap an app icon, such as Calendar or Contacts.
3. Do any of the following:
 - To see more details about an item, tap the notification.
 - To open the app associated with the notification, tap **More** or **Open**. You can return to the BlackBerry Productivity Tab screen from an app when you swipe on the tab again.
4. To close the tab, swipe toward the edge of the screen.

Create an item using the BlackBerry Productivity Tab

You can add new items, such as calendar events or email messages, right from the BlackBerry Productivity Tab without opening your calendar or email apps.

1. Swipe on the tab toward the center of the screen.
2. Tap an app icon.
3. Do one of the following:
 - To add an event, task, or contact, tap .

- To compose an email, tap .

Customize the BlackBerry Productivity Tab settings

You can adjust the BlackBerry Productivity Tab to best suit your needs and find what works for you.



1. Swipe in on the tab toward the center of the screen.
2. Tap , and then do any of the following:
 - To remove the tab from your screen, tap **Remove**. To turn on the tab, in Display settings, turn on the **Productivity Tab** switch.
 - To change the placement of the tab to another side of your device screen, tap **Left edge** or **Right edge**.
 - To change the length of the tab, slide your finger left or right on the **Height** slider.
 - To adjust the transparency of the tab, slide your finger left or right on the **Transparency** slider.

Tip: By default, the tab is centered on the side of your screen, but you can move the tab up or down along the edge of the screen. Touch and hold the tab, and drag it to your preferred spot. Release your finger to place the tab.





Storage & USB

Manage your files and folders

Search for a file or folder



1. Swipe down from the top of the screen once using two fingers, or twice using one finger.
2. Tap  > **Storage & USB**.
3. If necessary, tap **Internal storage**.
4. Tap **Explore**.
5. Tap .
6. Enter a search term, and then do one of the following actions:
 - On the touch screen keyboard, tap .
 - On the physical keyboard, press the **Enter** key.

Share, copy, or delete a file or folder

1. Swipe down from the top of the screen once using two fingers, or twice using one finger.
2. Tap  > **Storage & USB**.
3. If necessary, tap **Internal storage**.
4. Tap **Explore**.
5. Touch and hold a file or folder.
6. Do any of the following actions:
 - To share a file, tap  , and then select how you want to share the file.
 - To copy a file or folder, tap  > **Copy to**, and then select where you want to copy the file to. Tap **Copy**.
 - To delete a file or folder, tap  .

Tip: To select multiple files or folders, touch and hold a file or folder, and then tap each additional file or folder. To select all of the files in a folder or all of the folders on a screen, touch and hold a file or folder, and then tap  > **Select all**.

Sort your files or folders

1. Swipe down from the top of the screen once using two fingers, or twice using one finger.
2. Tap  > **Storage & USB**.
3. If necessary, tap **Internal storage**.
4. Tap **Explore**.
5. Tap  , and then tap **By name**, **By date modified**, or **By size**.

Tip: To change how your files and folders are displayed, tap  , and then tap **Grid view** or **List view**.

Using a media card

Get more space to store your ringtones, videos, pictures, songs, and more when you insert a microSD card into your device. By using a media card, you can expand your device's storage space by up to 2 TB. Using a media card can also help increase the performance and power efficiency of your device, and can allow you to transfer your data from your current device to another device that supports media card transfers.

To use a media card with a capacity greater than 32 GB, you must download Microsoft exFAT Technology for BlackBerry to install the driver. A notification appears when you insert the media card into your device. Make sure that you are connected to the Internet, and then tap the notification to download the driver.



A Class 10 card or faster is required to record videos in Ultra HD (4K).

[Learn how to insert a media card.](#)



Delete the data from your media card

To help protect your privacy, you can format your media card to permanently delete all of the data. Depending on the amount of data, this process might take some time.

CAUTION: When you format your media card, you can't recover any of the deleted data.

1. Make sure that your device isn't connected to a computer.
2. Swipe down from the top of the screen once using two fingers, or twice using one finger.
3. Tap  > **Storage & USB**.
4. Tap your media card.
5. Tap  > **Settings** > **Format**.

Remove a media card

1. Do one of the following:
 - Turn off your device.
 - Swipe down from the top of the screen once using two fingers, or twice using one finger. Tap  > **Storage & USB**. Tap your media card. Tap  > **Settings** > **Eject**.
2. With your device facing downwards, release the media card tray by pushing the tip of the tool (provided with your device) into the hole on the top-left of your device. If you don't have the tool that came with your device, you can also use a paper clip.

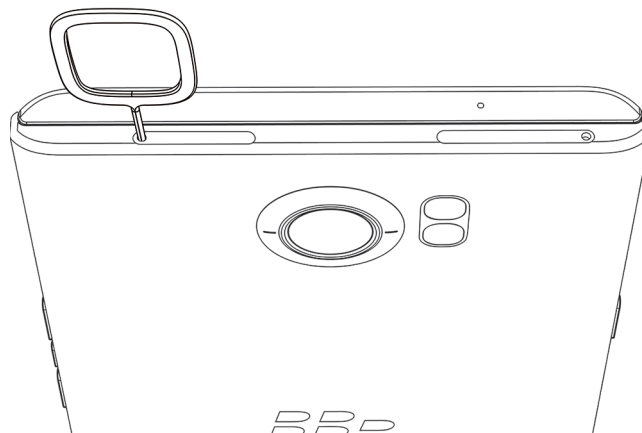



3. Pull out the tray completely and remove the media card.
4. Push the tray back into the slot.

Check how much storage space is free

1. Swipe down from the top of the screen once using two fingers, or twice using one finger.
2. Tap  > **Storage & USB**.
3. If necessary, tap **Internal storage**.
4. To see more details about an item in the list, tap the item. For example, to see which apps are using the most storage space, tap **Apps**.

Free up storage space

You may notice slower performance on your device if your device's internal storage space is full or almost full. You can try removing unnecessary files and clearing cached data to free up space and improve your device's performance.

1. Swipe down from the top of the screen once using two fingers, or twice using one finger.
2. Tap  > **Storage & USB**.
3. If necessary, tap **Internal Storage**.
4. Do any of the following:
 - To disable or uninstall an app that you don't use, tap **Apps**, and then tap an app. Tap . Tap **Disable** or **Uninstall**.
 - To delete files that you don't need, tap a category or tap **Explore**. Navigate to a file. Touch and hold the file. Tap any additional files that you want to delete. Tap .
 - To delete temporary files from your device by clearing your cache, tap **Cached data** > **OK**.

Transfer files between your computer and device using a USB connection

1. Using a USB cable, connect your device to your computer.
2. On your device, swipe down from the top of the screen and tap the **Connected in charging mode** notification.
3. Tap **File transfers** or **Photo transfer (PTP)**.
4. On your computer, if necessary, enter your device password. Your device and media card appear as drives on your computer.
5. Go to the files or folders that you want to copy.
6. Drag and drop the files or folders into the desired folders.
7. If necessary, before disconnecting your device, on your computer, right-click your device's drive. Click **Eject**.

Change how your device connects to your computer

Each time you connect your device to your computer, by default, your device connects in charging mode, and a notification appears in the notification tray that tells you which mode is in use. To change the connection mode, your device must be connected to your computer.

1. Swipe down from the top of the screen.
2. Tap the USB connection notification.
3. Select an option.

Battery and power

Check your battery power level and usage info

You can see which apps and features are using the most battery power and how much battery power you have left.

1. Swipe down from the top of the screen once using two fingers, or twice using one finger.
2. Tap  > **Battery**.

Charge your device

1. Hold the charging cable with the BlackBerry logo facing the front of the device, and insert the cable into the port on your device.
2. Plug the charger into a power outlet.



Keeping your battery charged

Your device uses a lithium-ion battery. To maximize your use of this type of battery, when possible, do the following:

- Avoid using your device while it's charging to help it charge faster.
- Do not leave your device plugged into a charger after it has reached a full charge.
- Avoid charging, using, or storing your device in extremely hot or cold places, such as on a vehicle dashboard.
- Avoid leaving your device turned off for an extended periods when the battery power level is low. If you plan to store your device for an extended period, partially charge the battery and put the device in a cool, dry place.

About wireless charging

Some service providers support wireless charging for your device. You can charge your device by setting it on a supported charging mat instead of connecting your device to a charger.







You can use the following device models with Qi and Power Matters Alliance (PMA) wireless chargers:

- STV100-1 smartphone
- STV100-2 smartphone

Tip: To find your device's model number, swipe down from the top of the screen once using two fingers, or twice using one finger, and then tap  > **About phone**.

Battery and charging icons

The battery power level icons appear at the top of the screen.

Icon	Description
	The battery is charging.
	The battery is fully charged and still connected to a power source.
	The battery is getting low on power.
	Battery saver mode is turned on, or you can turn it on from your list of notifications.
	The battery is at 5% power or less. If the battery charge gets too low, your device might turn off. Save any work in progress and charge your device.
	There is a problem with the battery, and the battery might need to be replaced.

About the battery edge indicator

When turned on, the battery edge indicator appears as a strip of color on the right edge of the screen. The strip grows and transitions from red to yellow to green as your device charges.

When your device is charging, the indicator displays the percentage of your current battery power and estimates how much time is left until the device is fully charged.

To avoid disturbing you, the indicator automatically disappears when the room is dark or when your battery power level reaches 100%. If your screen is turned on, the indicator automatically disappears after eight seconds.

Turn off the battery edge indicator

1. Swipe down from the top of the screen once using two fingers, or twice using one finger.
2. Tap  > **Display**.
3. Turn off the **Battery edge** switch.

How can I extend battery life?

To save battery power, your device automatically goes to sleep when you aren't using it, and apps that you don't use regularly are put in standby mode.

If your battery is still draining quicker than expected, you can change some device settings to extend battery life. Swipe down from the top of the screen once using two fingers, or twice using one finger. Tap , and then change any of the following settings.

Turn off network connections that you aren't using

When your device is outside a wireless coverage area, you can turn off your mobile network or Wi-Fi connections so that your device doesn't search for a wireless network signal continuously.

In the device settings, do any of the following:

- To turn off all connections, tap **More**. Turn on the **Airplane mode** switch.
- To turn off Wi-Fi only, tap **Wi-Fi**. Turn off the switch.

Delete saved Wi-Fi networks

1. In the device settings, tap **Wi-Fi**.
2. Tap a Wi-Fi network, and then tap **Forget**.

Shorten the length of time before your device goes to sleep

1. In the device settings, tap **Display**.
2. Tap **Sleep**, and then tap **15 seconds** or **30 seconds**.

Tip: If you don't want the screen turning off when you're in the middle of something, such as reading an article, your device can recognize when you're holding it in your hand and keep the screen on. In the device settings, tap **Advanced Interactions**. Turn on the **Hold to stay awake** switch.

Dim the screen

1. In the device settings, tap **Display > Brightness level**.
2. On the slider, drag the slider handle to the left.

Turn down the volume

1. In the device settings, tap **Sound & notification**.
2. On the **Media volume**, **Alarm volume**, or **Ring volume** sliders, drag the slider handle to the left.

Turn off key press feedback

1. In the device settings, tap **Language & input > BlackBerry Keyboard Settings > Key press feedback**.
2. Turn off the **Vibrate** switch and the **Sound** switch.

Turn on battery saver

If your device is low on battery power, you can turn on battery saver to limit features that use the most power, such as vibration, location services, and data services. You can set battery saver to turn on automatically when your battery power reaches a certain percentage.

Note: When battery saver is turned on, some applications and messaging services that rely on syncing might not update unless you open them.

1. In the device settings, tap **Battery > ⋮ > Battery saver**.
2. Turn on the switch.
3. To turn on battery saver automatically when your device is low on battery power, tap **Turn on automatically**. Tap a percentage.

Turn on battery optimization

By default, battery optimization is turned on for most apps and features. If you turned off battery optimization for an app, you might want to turn it back on again, at least until you have a chance to charge your device.

1. In the device settings, tap **Battery** >  > **Battery optimization**.
2. Tap an app.
3. Select the **Optimize** option, and then tap **Done**.

Device and battery safety

You should use only the battery that BlackBerry specifies for use with your particular BlackBerry device model. If you use any other battery, you might invalidate any warranty provided with your device.

CAUTION: There is a risk of explosion if the battery is replaced with an incorrect battery type. Do not try to replace your nonremovable battery. Only qualified service personnel should perform repairs or battery replacements in your device.

Device and battery disposal

Please recycle your device and battery in accordance with your local regulations. Do not dispose of either your device or battery in a fire. Your device or battery should not be placed in household waste bins. For information about returning your device to BlackBerry for recycling and safe disposal, from a browser on your computer visit <http://www.blackberry.com/recycling>. The recycling program is available only in certain areas.

View the safety, warranty, and privacy information for your device

Take a moment to review the license agreement, limited warranty, safety information, and privacy policies for your device. These documents are available from your device settings screen. They contain important information about terms and conditions of use, the battery, other important safety precautions, and warranty coverage.

To view BlackBerry's *Privacy Policy*, your device must be connected to the Internet.

1. Swipe down from the top of the screen once using two fingers, or twice using one finger.
2. Tap  > **About phone** > **Legal information** > **BlackBerry**.

Users

About users

The users feature lets you share your device with others while keeping your personal or work information private. For example, users that you add to your device can't access your info, such as your email, contacts, pictures, apps, and more. By default, your device is set up with a device owner and a guest. You can also add more user profiles to your device.

To improve privacy between users, each user should set up a screen lock. A screen lock prevents another user from accessing information in a different user profile.

All user profiles use the wireless connection information set up on the device. Any changes that a user makes to some device settings, such as Wi-Fi network connections, are available or applied to all users on the device.

All users can install app updates for any user on the device.

You (device owner)

The person who sets up the device for the first time (you) is the device owner. You can add up to three users in addition to the device owner and a guest, and set whether the guest or user can use the device to make calls or send text messages. You control whether someone can add and access a user from the lock screen. You can also install app updates for all users on the device, uninstall apps from a user profile, and delete a user from the device.

Guest

You can use the guest profile to let someone borrow your device. When someone uses the guest profile, the device creates a separate space where the guest can download apps, take pictures, and use other device features. Apps and data added to your device by the guest are only available from the guest profile. When you or the guest delete the guest profile, the apps and data in the guest profile are permanently deleted from the device.

You control whether the guest can make and receive phone calls.

User

While the guest profile allows you to let someone borrow your device occasionally, you can create a user profile for someone that you share your device with frequently. A user profile creates a separate space on the device where another person can use device features and customize the device to their liking. For example, you might want to create a "kids" user profile that contains child-friendly apps. When a child wants to use your device, you can switch to the "kids" user profile and not worry that your apps or data might accidentally be deleted or changed. Apps and data added to the device by the user are only available from the user profile.

You control whether the user can make and receive phone calls, and whether the user can send and receive text messages (SMS).

Add a user

A user profile creates a separate space on your device for another person to use and customize. For example, the user can add a Google™ account or download apps, wallpaper, and music without seeing the device owner or other users' account info, apps, and data.



1. Swipe down from the top of the screen once using two fingers, or twice using one finger.
2. Tap  > **Users** > **Add user**.
3. Tap **OK**.
4. Tap **Set up now**.
5. If necessary, to wake up your device, swipe up from the bottom of the screen.
6. Complete the instructions on the screen.

Switch users

1. Swipe down from the top of the screen once using two fingers, or twice using one finger.
2. Tap  > **Users**.
3. Do one of the following:
 - Tap a user.
 - Tap **Guest**.



Allow access to guest and user profiles when your device is locked

Guests and users can access their profiles from the lock screen if you set up your device to allow this feature. This feature also lets you add a user from the lock screen without having to unlock the screen first.

1. Swipe down from the top of the screen once using two fingers, or twice using one finger.
2. Tap  > **Users** > .
3. Select the **Add users when device is locked** checkbox.



Allow a user to make calls and send text messages



You can set whether a guest or user can make or receive calls when they use the guest profile or a user profile on your device. You can also set whether a user can send or receive text messages (SMS).

1. Swipe down from the top of the screen once using two fingers, or twice using one finger.
2. Tap  > **Users**.
3. Do any of the following:
 - Beside the guest profile, tap  . Tap the **Turn on phone calls** switch.
 - Beside a user profile, tap  . Tap the **Turn on phone calls & SMS** switch.

Delete a user or guest

When you delete a user from your device, you permanently delete the user's space and all of the apps and data in it. The user is no longer available from the list of users. When you delete a guest, all of the apps and data in the guest space are permanently deleted, but the guest profile remains on the device.

1. Swipe down from the top of the screen once using two fingers, or twice using one finger.
2. Tap  > **Users**.
3. Do one of the following:
 - Beside the user you want to delete, tap  > **Remove user** > **Delete**.
 - Tap **Guest**. If necessary, tap **Yes, continue**. Swipe down from the top of the screen once using two fingers, or twice using one finger. Tap  > **Users** > **Remove guest** > **Remove**.

A guest or a user can delete the apps and data from the guest space or user profile space on your device. A guest can tap  > **Delete Guest from this device**. A user can tap  > **Delete <username> from this device**.

Advanced interactions

You can use motion gestures to do things more quickly or efficiently. To turn motion gestures on or off, swipe down from the top of the screen once using two fingers, or twice using one finger. Tap  > **Advanced interactions**.

Flip to mute

If this feature is turned on, when you receive a call and it isn't a convenient time to respond, you can turn your device facedown on a flat surface to silence the ringtone or vibration. You still receive a notification of the missed call.

To turn this feature on or off, tap the **Flip to mute** switch.

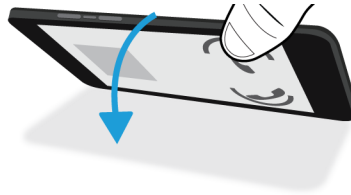

Flip to save power

If this feature is turned on, when you place your device facedown on a flat surface, your device goes into sleep mode to extend battery life. You still receive notifications for incoming calls, messages, and alarms.

To turn this feature on or off, tap the **Flip to save power** switch.

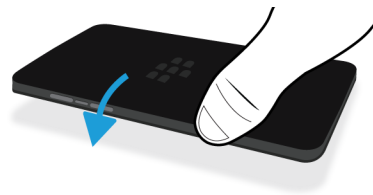

Hold to stay awake

If this feature is turned on, the screen stays on longer when you hold your device in your hand.

To turn this feature on or off, tap the **Hold to stay awake** switch.



Location

About location services

You can turn on location services so that location-based applications and services, like Google Maps™, can find your location. Location-based applications can use GPS technology and other positioning information to provide you with information, such as driving directions.

From the Location settings screen, you can also see the apps that are using location services. If you decide that you don't want an app to know your location, you can turn off location permissions for that app. [For more information about turning app permissions on or off, see the help for Security.](#)

Turn location services on or off

1. Swipe down from the top of the screen once using two fingers, or twice using one finger.
2. Tap **⚙️ > Location**.
3. At the top of the screen, turn the switch on or off.

Turn on accelerated location

Accelerated location is designed to find your location accurately and quickly, even when you're inside a building.

1. Swipe down from the top of the screen once using two fingers, or twice using one finger.
2. Tap **⚙️ > Location > Accelerated location**.
3. Select the **Location consent** checkbox.

Change location modes

You can change how your device determines your location. For example, if your battery is running low, you can switch to battery saving mode.

1. Swipe down from the top of the screen once using two fingers, or twice using one finger.
2. Tap  > **Location** > **Mode**.
3. Tap an option.

Turn location history on or off

Location history is a Google™ service that creates a private map of where you go with your device, and uses the map to give you useful information, such as commute predictions and more relevant search results.

1. Swipe down from the top of the screen once using two fingers, or twice using one finger.
2. Tap  > **Location** > **Google Location History**.
3. If necessary, add your Google™ account.
4. At the top of the screen, turn the switch on or off.

Accounts

Manage your accounts

Add an account

You can add an account, such as a Microsoft Exchange or Yahoo! email account, to your device.

1. Swipe down from the top of the screen once using two fingers, or twice using one finger.
2. Tap  > **Accounts** > **Add account**.
3. Tap the type of account that you want to add.
4. Complete the instructions on the screen.



If you added an email account to your device, you can send and respond to messages using the BlackBerry Hub. To add an email account to the BlackBerry Hub, in the BlackBerry Hub, tap  > **Add account**. Complete the instructions on the screen.

Change the settings for an account

1. Swipe down from the top of the screen once using two fingers, or twice using one finger.
2. Tap  > **Accounts**.
3. Tap the type of account, and if necessary, tap the account.
4. Make your changes.

Note: To stop syncing information for all accounts (for example, to save battery life), on the Accounts screen, tap , and then clear the **Auto-sync** checkbox.

Delete an account

1. Swipe down from the top of the screen once using two fingers, or twice using one finger.
2. Tap  > **Accounts**.
3. Tap the type of account that you want to delete, and if necessary, tap the account.
4. Tap  > **Remove account**.

Backup & reset

About backing up device data

Each method for backing up the data on your device backs up different types of data. Consider using a combination of these methods to back up your data.

Backup method	Description
Android™ Backup Service	<p>With Android™ Backup Service, you can back up your data to your Google™ account. If you must replace your device unexpectedly (for example, if your device is damaged, lost, or stolen), you can restore your data on a device running Android™.</p> <p>The following types of data can be backed up to a Google™ account:</p> <ul style="list-style-type: none"> • Google Calendar™ settings • Wi-Fi networks and passwords • Home screen wallpapers • Gmail™ settings • Apps installed on Google Play™ • Display settings

Backup method	Description
	<ul style="list-style-type: none"> • Language and input settings • Date and time settings • Third-party app settings and data (depending on the app)
Google Drive™	<p>Some apps back up application data in Google Drive™.</p> <p>To check which apps are backed up in Google Drive™, in the Google Drive™ app, tap  > Settings > Manage backup.</p>
Transfer files to your computer	<p>You can connect your device to your computer using a USB cable, view your device's files in your computer's file manager, and copy the files (such as pictures and documents) to your computer. This is a manual process. BlackBerry does not provide desktop software for Android™ devices. For more information, see Transfer files between your computer and device using a USB connection.</p>
Use a third-party backup service	<p>The Google Play™ store includes many apps that provide backup services. BlackBerry cannot guarantee the security or trustworthiness of these apps, so use caution when considering a third-party backup service.</p>

Back up and restore data using Android™ Backup Service

Turn Android™ Backup Service on or off

If Android™ Backup Service is turned on, your data is backed up automatically every 24 hours when your device is plugged in, idle, and connected to a Wi-Fi network. If you reset your device or switch to another Android™ device, your data is restored when you add the Google™ account that you used to back up your data to your device.

1. Swipe down from the top of the screen once using two fingers, or twice using one finger.
2. Tap  > **Backup & reset**.
3. Tap **Back up my data**.
4. Turn the switch on or off.

Change the Google™ account that you use to back up device data

1. Swipe down from the top of the screen once using two fingers, or twice using one finger.
2. Tap  > **Backup & reset** > **Backup account**.
3. Do one of the following:
 - Tap an account.

- Tap **Add account**. Complete the instructions on the screen.

Delete your device data with a factory reset

Before you switch to a new device or give away your current device, you should delete your data. A factory reset is designed to delete all of the data on your device permanently so that it can't be recovered. The permanently deleted data includes email accounts, downloaded apps, media files, documents, browser bookmarks, and settings.

Important: If you delete your device data in any other way, for example, by entering the screen lock incorrectly ten times, when your device restarts, it will not work again until you enter your Google™ account credentials. After a factory reset, you do not need to enter your Google™ account credentials.

1. Swipe down from the top of the screen once using two fingers, or twice using one finger.
2. Tap  > **Backup & reset**.
3. Tap **Factory data reset** > **Reset phone**.
4. If necessary, enter your screen lock.
5. When prompted, tap **Erase everything**.

I can't get out of safe mode

To get out of safe mode, press and hold the **Power on/off** key (on the left side of your device). Tap **Restart**.

Accessibility

About accessibility features on your device

Your device comes with several well-established accessibility aids for people with disabilities.

For more information on the following features, visit [Android Accessibility Help](#).

- Magnification settings allow you to zoom in or zoom out to increase or decrease the display magnification.
- Google™ TalkBack provides audible output based on the visual information displayed on your screen.
- Switch Access allows you to navigate screens on your device using external switches.
- Braille support is available using BrailleBack.
- Font customization allows you to choose small, medium, large, or huge sizes.
- Screen Reader technology lets you select the text-to-speech application that you prefer to use (if you have downloaded an alternate text-to-speech engine on Google Play™).
- Google Now™ voice assistant answers questions, makes recommendations, and performs actions.
- Voice dictation allows you to dictate text instead of typing.

- Closed or open captioned multimedia content is available. Personalize your closed caption settings by adjusting character size, color, opacity, or font.
- Display features, such as color inversion and color correction, are applied across all applications.
- The touch & hold delay feature lets you increase the length of time for touch responses on the screen.
- Third-party keyboards are supported.
- The ability to speak your passwords is included.
- An accessibility shortcut is available that you can use to quickly change your accessibility settings.
- Teletypewriter (TTY) support allows you to connect to a TTY device to make and receive calls from TTY devices.

For more information on the following features, visit [BlackBerry Accessibility](#).

- Hearing aid compatibility is available for certain BlackBerry smartphone models. Compatibility ratings are available online at [BlackBerry Accessibility](#).
- The BlackBerry Keyboard lets you type more efficiently with contextual autocorrection, next-word prediction, and personalized learning that gets to know the way you type.
- If your device has a physical keyboard, keyboard shortcuts and speed dial allow you to assign actions and phone numbers to specific keys.
- If you are using PRIV, you have the option of using the touch screen keyboard, or the slide-out keyboard with tactilely discernible keys.
- Alerts and notifications can be customized using tone, vibration, onscreen alerts, or the LED indicator.
- An integrated hands-free speakerphone is available, or you can connect your device to a hands-free headset or Bluetooth enabled headset.

Change accessibility settings

You can turn accessibility settings on or off, such as Google™ TalkBack, captions, touch & hold delay, and color inversion.

1. Swipe down from the top of the screen once using two fingers, or twice using one finger.
2. Tap  > **Accessibility**.
3. Set the accessibility options switches.

Turn on Hearing Aid mode

Hearing Aid mode is designed to improve the compatibility of your device with a hearing aid equipped with a telecoil. This feature might not be supported depending on your BlackBerry device model. Hearing aid compatibility ratings are available online at [BlackBerry Accessibility](#).

1. In the Phone app, in the upper-right corner of the screen, tap .
2. Tap **Settings** > **Accessibility**.
3. Select the **Hearing aids** checkbox or turn on the **Hearing aids** switch.

Turn on TTY support

TTY support is designed to allow your device to connect with an external TTY device that converts received calls to text.

The TTY device that you want to connect to your BlackBerry device must operate at 45.45 bps. If your TTY device is designed for use with a 2.5-mm headset jack, you must use an adapter accessory to connect your TTY device to your device. The adapter end that plugs into the TTY device must be a male three pole mono 2.5-mm headset jack, and the end that plugs into your BlackBerry device must be a male four pole stereo 3.5-mm headset jack.

1. Connect a TTY device to your device according to the instructions that came with your TTY device.
2. In the Phone app, in the upper-right corner of the screen, tap .
3. Tap **Settings > Accessibility > TTY mode**.
4. Select one of the following TTY modes:
 - To turn off all TTY settings, tap **TTY Off**.
 - To turn on all TTY settings, tap **TTY Full**.
 - To turn on TTY Hearing Carry Over mode, tap **TTY HCO**.
 - To turn on TTY Voice Carry Over mode, tap **TTY VCO**.

Update your device software

Updating your device software to the latest version can help your device stay secure and run as expected.

Do one of the following:



- To update your device software when a notification appears, swipe down from the top of the screen using one finger. On the system update notification, tap **Install**.
- To update your device software manually, swipe down from the top of the screen once using two fingers, or twice using one finger. Tap  > **About phone > System updates > Check for update**. If an update is available, tap **Restart & install**.

Note: Major updates can take time to download and install and require that you restart your device. To help prevent issues, keep your device connected to a power source and a reliable Wi-Fi network while the update is in progress.

Printing



Print from your device

You can print webpages, photos, documents, and more from your device using compatible Wi-Fi or Bluetooth enabled printers and printers connected to your computer. Not all applications support printing.

1. In an app, tap  > **Print**. Depending on the app, this option might appear in a different location, or might be called something different, such as **Share & export**.
2. Tap the top of the screen, and then tap the printer that you want to use.
3. Tap .

Note: You may have to install a printing service and add a printer before you can print.

Install a printing service

1. Swipe down from the top of the screen once using two fingers, or twice using one finger.
2. Tap  > **Printing**.
3. Tap **Add service**.
4. Tap the service that's compatible with your printer, and then tap **Install**. To find a compatible service, find your wireless printer's brand or consult its user guide.
5. Tap  twice.
6. Tap the printer service that you just installed. If the service isn't listed, swipe down from the top of your screen, and then tap the notification for your newly installed printer service.
7. Turn on the switch for that service, and then tap **OK**. Wait for the service to find printers automatically.

Add a printer

In most cases, after you install a printer service, your device finds your printer automatically. If your device can't find your printer, you might be able to add it manually.

1. Swipe down from the top of the screen once using two fingers, or twice using one finger.
2. Tap  > **Printing**.
3. Tap the printer service for the printer that you want to use. If the printer service is turned off, turn it on.
4. Tap **Add printer**.
5. Follow the instructions on the screen.

Printing using Google Cloud Print™

You can use Google Cloud Print™ to print from your device to a Cloud Ready printer or to any printer that's connected to a computer.

To print to a printer that's not Cloud Ready, you must also do the following:

- Make sure that Google Chrome™ is installed on your computer, and then log in to the same Google™ account that you use on your device.
- When you print, make sure that your computer is turned on.

To learn more about setting up and using Google Cloud Print™, see <https://support.google.com/cloudprint/>.

Security

Locks, passwords, and protecting your data

There are several types of locks, PINs, and security features that you can use to help protect the data on your device.

If you use your device for work, your organization might have security rules in place. The organization might require you to enter a password to unlock your device or might prevent you from using the Smart Lock feature.

Screen lock

A screen lock helps prevent someone else from unlocking your device and accessing your data. When you set up a screen lock, you set whether the screen lock must be entered to turn on the device.

Some security features, such as Smart Lock, require that you set up a screen lock before you can set up the feature.

There are several types of screen locks to choose from. Each type is designed to provide a different level of security.

- **Password:** A secure password can contain letters, numbers, and symbols. A password is designed to be a strong screen lock that is difficult for someone else to figure out.
- **PIN:** A PIN must contain a minimum of four numbers. The more numbers there are in your PIN, the more secure your screen lock.
- **Pattern:** A pattern is a continuous line that connects four or more dots on a grid. You trace your pattern to unlock your device.
- **Swipe:** A swipe gesture can unlock your device.

Picture Password

The Picture Password feature lets you unlock your screen using a unique number and picture combination that you create. To unlock your screen, you move a number grid and align a number (that you choose) over the specific location (that you choose) on a picture (that you also choose). A picture password provides a convenient way to unlock your device and is difficult for someone else to figure out.

Before you can set up a picture password, you must set a screen lock that uses either a password or a PIN. If you enter your picture password incorrectly five times, your device prompts you to enter your screen lock password or PIN to unlock your screen.

Smart Lock

The Smart Lock feature lets you set up your device to remain unlocked when it's connected to a trusted Bluetooth enabled device or NFC-enabled device, when it recognizes your face or voice, or when you are carrying it in your hand, pocket, or

bag. The Smart Lock feature also allows your device to remain unlocked when it's in a familiar location, such as your home or workplace.

The Smart Lock feature is a convenient way to access the data on your device, but it doesn't confirm that the device owner is the person using the device.

You must have a screen lock set before you can set up the Smart Lock feature.

Data encryption

By default, data on your device, including your account information, apps, music, pictures, and other downloaded files, is stored in a format that can be read only when your device decrypts the data. If you set up a screen lock and require that it must be entered to turn on your device, your password, PIN, or pattern is used to generate a new encryption key to decrypt your data.

SIM card PIN

You can set up a PIN for your SIM card, which you can use to help prevent unauthorized use of your SIM card in another device. For example, if you lose your SIM card and someone tries to use it in another device, the SIM card can't be used unless the PIN is entered correctly.

Network lock and unlock codes

To use a SIM card from another service provider, for example, if you're traveling and want to use a local service provider's network, you can request unlock codes (MEP codes) from your current service provider. After you insert the new SIM card, enter the unlock code.

If you exceed the number of allowed attempts to enter an unlock code, your SIM card allows emergency calls only. For assistance, contact your service provider.

Google™ account and factory reset protection

The factory reset protection feature uses your Google™ account information to help protect the data on your device. If your device is lost or stolen, the factory reset protection feature is designed to prevent someone else from being able to set up your device for use, even if that person tries to reset your device to its factory settings. The device must be set up using the same Google™ account information that was set up on the device before it was reset.

To use the factory reset protection feature, you must set up a screen lock and you must add your Google™ account to your device.

Set up or change a screen lock

Locking your device can help prevent your device from sending accidental messages or pocket dialing. Before you can unlock your device and access the data on your device, you must enter your password, PIN, or pattern, or swipe the screen.

If you use your device for work, depending on the rules set up by your administrator, you might not be able to use a pattern or swipe gesture to unlock your device.

Note: Using a swipe gesture to unlock your screen is not a secure way to prevent others from accessing the data and features on your device.

1. Swipe down from the top of the screen once using two fingers, or twice using one finger.
2. Tap  > **Security** > **Screen lock**.
3. If necessary, enter your current password, PIN, or pattern.
4. Tap the type of screen lock that you want to use.
5. Complete the instructions on the screen.

Set your screen lock options

After you set up a screen lock for your device, you can set up your screen lock options. For example, you can set how long your device can be inactive before it automatically locks and whether your device automatically deletes your device data if you enter your password incorrectly ten times.

1. Swipe down from the top of the screen once using two fingers, or twice using one finger.
2. Tap  > **Security**.
3. Do any of the following:
 - To lock your device automatically after a certain amount of inactive time, tap **Automatically lock**, and then tap an interval.
 - To lock your device when you press the **Power on/off** key, turn on the **Power button instantly locks** switch.
 - To delete your device data automatically after ten unsuccessful attempts to unlock the device, turn on the **Automatically wipe** switch.
 - To display a message or owner information on the screen when the device is locked, tap **Lock screen message**. Type the info to display, and then tap **Save**.
 - To hide your password, PIN, or pattern so that it is not visible when you unlock your screen, turn off the **Make passwords visible** switch.

Creating a strong password

A strong password helps prevent someone else from accessing your information. Weak passwords, such as 1234, might be easy to remember but they're easier to guess as well.

To create a strong password, avoid using a password with the following characteristics (in order of importance):

Avoid	Example
Common passwords	password
Words from a dictionary	quarter
Combining words from a dictionary	SimpleGraph
Names or addresses	Cecilia
Adding numbers at the end of a word	password145

The key is to create a strong password that you can remember easily. Consider the following tips:

Do	Example
Use as many characters as you can remember	–
Combine words from different languages	field of Kühe Instead of: field of cows
Mix character sets	größere3 stre4gth
Use the first letter from each word in a sentence	Tqbfjotld Instead of: The quick brown fox jumps over the lazy dog
Combine misspelled words	SimzleGarph Instead of: SimpleGraph

Set up Picture Password to unlock your screen

The Picture Password feature lets you unlock your device using a unique number and picture combination. To unlock your screen, you move a grid to align a number over a specific location on a picture. You choose the number, location, and picture. It is difficult for another person to guess your picture password even if the other person watches you unlock your screen.

Before you can set up the Picture Password feature, you must set up a screen lock that uses either a password or a PIN. If you enter your picture password incorrectly five times, your device prompts you to enter the password or PIN to unlock your screen.

CAUTION: You won't be able to use Picture Password to unlock your device when you restart it if you chose the option to require a password or PIN to start your device. When you restart your device, you'll have to use your password or PIN to unlock it. You can use Picture Password to unlock your device at any other time.

Turn on Picture Password

Make sure that you have set a screen lock for your device that uses either a password or a PIN.

1. Swipe down from the top of the screen once using two fingers, or twice using one finger.
2. Tap  > **Security** > **Picture Password**.
3. Enter your password or PIN.
4. Complete the instructions on the screen.

About Smart Lock

The Smart Lock feature makes it easy for you to unlock your device. You can set up your device to remain unlocked in the following situations:

- When your device is connected to a trusted Bluetooth enabled device or NFC-enabled device
- When your device is in a familiar location, such as your home or workplace
- When your device recognizes your face or voice
- When you carry your device in your hand, pocket, or bag

The Smart Lock feature can't detect who is holding your device when the device is unlocked and connected to a trusted device, in a trusted location, or passed between people while on-body detection is turned on. It might also be possible for someone who looks like you to unlock your device when you turn on the trusted face option.

If you use your device for work, depending on the rules set by your administrator, the Smart Lock feature might not be available.

Set up Smart Lock to unlock your device

Make sure that you have set a screen lock on your device. Depending on the type of Smart Lock you set up, you might need to turn on or set up other features on your device, such as Bluetooth technology, NFC, Google Maps™, "Ok Google™" voice detection, a trust agent, or a wireless network connection.

1. Swipe down from the top of the screen once using two fingers, or twice using one finger.
2. Tap  > **Security** > **Smart Lock**.
3. Enter your password, PIN, or pattern, and then tap **Next**.
4. Do any of the following:
 - To keep your device unlocked when it is connected to a Bluetooth enabled device, when you tap an NFC tag, or when you tap an NFC-enabled device, tap **Trusted devices**.
 - To keep your device unlocked when it detects it is at home or at another trusted location, tap **Trusted places**.
 - To unlock your device when it recognizes your face, tap **Trusted face**.
 - To unlock your device when you say "Ok Google™," tap **Trusted voice**. If necessary, turn on the **From the Google app** switch. Turn on the **From any screen** switch. If necessary, set up the "Ok Google™" voice detection feature, and then turn on the **Trusted voice** switch.
 - To keep your device unlocked when you carry it on your body or in a bag, tap **On-body detection**, and then turn on the switch.
5. Complete the instructions on the screen.

Turn off Smart Lock

1. Swipe down from the top of the screen once using two fingers, or twice using one finger.
2. Tap  > **Security** > **Smart Lock**.
3. Enter your password, pattern, or PIN, and then tap **Next**.
4. Do any of the following:
 - Tap **Trusted devices**. Tap a device, and then tap **Remove trusted device**.
 - Tap **Trusted places**. Tap a location, and then tap **Turn off this location**.
 - Tap **Trusted face**. Tap **Remove trusted face**, and then tap **Remove**.
 - Tap **Trusted voice**. Turn off the **Trusted voice** switch.
 - Tap **On-body detection**. Turn off the switch.
5. If you turn off all of your Smart Lock settings, you should also turn off the Smart Lock trust agent:
 - a. Go back to the Security screen and tap **Trust agents**.
 - b. Turn off the **Smart Lock (Google)** switch.

Protect your SIM card with a PIN

You can use a SIM card PIN to help prevent unauthorized use of your SIM card in another device. For example, if you lose your SIM card and someone tries to use it in another device, the SIM card can't be used unless the PIN is entered correctly. After you set up a PIN for your SIM card, you must enter the PIN from the lock screen to use your device.

1. Swipe down from the top of the screen once using two fingers, or twice using one finger.
2. Tap  > **Security** > **Set up SIM card lock**.
3. Turn on the **Lock SIM card** switch.
4. Type a PIN, and then tap **OK**.

To remove the PIN from your SIM card, turn off the **Lock SIM card** switch. Type the PIN for your SIM card, and then tap **OK**.

Change the PIN for your SIM card

1. Swipe down from the top of the screen once using two fingers, or twice using one finger.
2. Tap  > **Security** > **Set up SIM card lock**.
3. Tap **Change SIM PIN**.
4. Follow the instructions on the screen.

About smart cards

Smart cards store certificates and private keys. You can import certificates from a smart card to your device by using an external smart card reader or a microSD smart card. Private key operations such as signing and decryption use the smart card. Public key operations such as verification and encryption use the public certificates on your device.

You can use smart card certificates with third-party apps that support smart card technology. And you can use smart card certificates to send S/MIME-protected messages.

Store your smart card password on your device

You can set up your device to store your smart card password temporarily, so that you don't have to enter it as often. To remove the password from your device cache, lock your device.

1. Swipe down from the top of the screen once using two fingers, or twice using one finger.
2. Tap  > **Security** > **Smart Card**.
3. Turn on the **PIN Caching** switch.

Set or change the PIN for your smart card reader

1. Swipe down from the top of the screen once using two fingers, or twice using one finger.
2. Tap  > **Security** > **Smart Card**.
3. Tap a smart card reader.
4. Do one of the following:
 - Tap **Set PIN**.
 - Tap **Change PIN**.
5. Complete the instructions on the screen.

Troubleshooting: Locks, passwords, and protecting your data

I forgot my password, PIN, or pattern



For security reasons, the only way that you can reset your screen lock without knowing the password, PIN, or pattern is to delete all of your device data and set up the device again.

You can typically do this by entering your password, PIN, or pattern incorrectly ten times. Or, if you have a remote device management app installed on your device, such as the Android™ Device Manager, you can log in to the website and delete your device data.

If you add your Google™ account to your device, the factory reset protection feature is turned on. To set up your device again, you must add the same Google™ account. If you don't use the same Google™ account, you can't complete the setup process.

Smart Lock doesn't unlock my device as expected

Try any of the following;

- If your device doesn't unlock when you scan your face, try to improve the image Smart Lock uses to recognize your face. Tap  > **Security** > **Smart Lock** > **Trusted face** > **Improve face matching**.
- Adjust the distance between your BlackBerry device and a trusted Bluetooth enabled device. The distance of a Bluetooth connection can vary depending on your BlackBerry device model and the Bluetooth enabled device.
- If your device remains unlocked when it is close to a trusted location instead of when you are at the trusted location, try improving the accuracy of the trusted location. Delete the trusted location. Tap  > **Location** > **Mode**. Tap **High accuracy** or **Battery saving**, and then add the trusted location again. Your device might detect a trusted location outside of the physical walls of a building, such as your house. Smart Lock might keep your device unlocked when it is within an 80-meter radius of a trusted location.
- You might need to unlock your device using your screen lock the first time you connect to a trusted device or arrive at a trusted location.

Finding and protecting a lost device

What to do if your device is lost or stolen

If you have a remote device management app, such as Android™ Device Manager, set up on your device, visit the remote device management website and sign in. Depending on the remote device management app installed on your device, you might be able to:

- Lock your device
- Make your device ring
- Add a phone number or message to the home screen of your device
- View the approximate location of your device on a map
- Delete all of the data on your device

If your device is not connected to the wireless network or if data services are turned off, you should still try to lock your device and delete your device data. The next time your device connects to a wireless network, or data services are turned on, your device is designed to lock and delete all the data.

If you don't have a remote device management app set up on your device, contact your service provider or your administrator and report that your device is lost or stolen. Your service provider can lock your device remotely and delete your data. If you use your device for work, your administrator might also be able to lock your device and delete your data.

If you suspect your device was stolen and you locate your device using a remote device management website, contact the local law enforcement agency to retrieve your device. Don't try to retrieve your device on your own.

Set a device administrator

By default, the Android™ Device Manager is set up as the device administrator for your device. If you download a third-party remote device management app to help you find your device or protect your device data, you must set the app as a device administrator.

1. Swipe down from the top of the screen once using two fingers, or twice using one finger.
2. Tap  > **Security** > **Device administrators**.
3. Tap the app.
4. Tap **Activate**.

About Android™ Device Manager

Android™ Device Manager includes features designed to help you find your device and help protect the data on your device if your device is lost or stolen.

On the [Android Device Manager website](#), you can view the approximate location of your device on a map, make it ring, set a password to lock your device and display a message on the lock screen, or delete all of the data from your device. If your device is turned off, doesn't have a valid SIM card in it, or isn't connected to the wireless network, the Android™ Device Manager will complete the request the next time your device is turned on and connected to the wireless network.

The Android™ Device Manager app is preloaded on your device. If someone you know loses an Android™ device, you can let that person log in to the Android™ Device Manager app to try to find the lost device.

To learn more about how to set up and use Android Device Manager, visit support.google.com and search for Android Device Manager.

Change your Android™ Device Manager settings

1. Swipe down from the top of the screen once using two fingers, or twice using one finger.
2. Tap  > **Google** > **Security**.
3. Do any of the following:
 - To be able to locate your device if it is lost or stolen, turn on the **Remotely locate this device** switch.
 - To be able to lock your device and delete all of your device data if it is lost or stolen, turn on the **Allow remote lock and erase** switch.

Security settings

About app permissions

When you download an app that is designed for Android™ 6.0 or later, you can install the app on your device without accepting any app permissions. When you use the app, the app prompts you for permission to access certain data or features on your device before it completes an action. For example, if the BlackBerry Hub wants to access your contacts, you can allow or deny the permission request.



You can also turn a permission on or off at any time, although some features of the app might not be available. In some cases, turning off a permission can prevent the app from working properly, or the app might not work at all. For example, if you turn off microphone access for the BlackBerry Keyboard, the voice dictation feature doesn't work. If you turn off camera access for the BlackBerry Camera, the app doesn't work at all.

When you download an app designed for an earlier version of the Android™ OS, you must accept all permissions before you can successfully install the app. If you install the app, and then later don't want the app to have access to a permission, turning off a permission stops the app from working correctly. If you don't want the app to have access to a permission, you should uninstall the app from your device.

Turn a permission on or off for an app

You can turn a permission on or off to control what features or personal information an app or an Android™ OS system service can access. When you turn off a permission, depending on the app, the app might continue working, but some features of the app might not be available. The app might also stop working properly, or the app might not work at all.

If you use your device for work, your administrator might control which permissions you can change.

1. Swipe down from the top of the screen once using two fingers, or twice using one finger.
2. Tap  > **Apps**.
3. Do one of the following:
 - To view the permissions for an app, tap the app.
 - To view the permissions for an Android™ OS system app or service, tap  > **Show system**, and then tap the app or service.
4. Tap **Permissions**.
5. Turn on or off a permission switch.
6. If necessary, tap **Deny**.

To see a list of apps and system services that access a specific type of permission, from the **Apps** screen, tap  > **App permissions**, and then tap a permission.

Download apps from sources other than Google Play™

Google Play™ is the default trusted source for downloading Android™ apps onto your device.

You can set up your device to let you download apps onto your device from other websites and sources. If you want to download apps from other sources, you should also set up your device to scan for malicious app activity.



1. Swipe down from the top of the screen once using two fingers, or twice using one finger.
2. Tap  > **Security**.
3. Turn on the **Unknown sources** switch.
4. Tap **OK**.

Scan device for malicious activity

You can set up your device to scan periodically for malicious activities. Your device warns you about potentially harmful app activity.

1. Swipe down from the top of the screen once using two fingers, or twice using one finger.
2. Tap  > **Google** > **Security**.
3. Turn on the **Scan device for security threats** switch.

About screen pinning

Screen pinning lets you pin one app into the foreground on your device. The feature disables the  and  buttons on your device so that the only way to close a pinned app is to unpin the screen. You can set up screen pinning so that you must enter your screen lock to unpin the screen.

Screen pinning allows you to let someone else use your device, for example, to play a game or view a video, without worrying that the person might close the app and access your data.



Turn on screen pinning



1. Swipe down from the top of the screen once using two fingers, or twice using one finger.
2. Tap  > **Security** > **Screen pinning**.
3. Turn on the switch.
4. To unpin a screen without entering your screen lock, turn off the **Ask for Password/PIN/Pattern before unpinning** switch.

To turn off the screen pinning feature, turn off the switch.

Pin a screen

Make sure that you have turned on the screen pinning feature.

1. Open an app or a screen that you want to pin to the foreground of your device.
2. Tap .
3. On the app or screen that you want to pin, tap .

To unpin a screen, touch and hold  and  at the same time. If necessary, enter your screen lock.

Install a certificate

Some Wi-Fi and VPN networks require your device to have a security certificate before the device can connect to the network. You can install a certificate to help identify your device. Typically, when you install a client certificate, a certification authority (CA) certificate is installed on your device at the same time.

1. Connect your device to your computer using a USB cable.
2. Copy the certificate or keystore to the root of the internal storage space on your device, your media card, or your Google Drive™ account.
3. Swipe down from the top of the screen once using two fingers, or twice using one finger.
4. Tap  > **Security** > **Install from SD card**.
Your device only displays certificates and keystores that are not already installed on your device.
5. Find and tap the certificate or keystore that you want to install.
6. If necessary, type the password for the certificate or keystore, and then tap **OK**.
After the certificate or keystore is installed, your device deletes the copy of the file on your device or media card.
7. Type a name to identify the certificate or keystore.
8. In the **Credential use** drop-down list, tap an option.
9. Tap **OK**.

Remove or turn off a certificate

When you remove a certificate that you installed, it is deleted from your device. If you require the certificate again, you must reinstall it. When you turn off a system certificate, you can turn it on again.

1. Swipe down from the top of the screen once using two fingers, or twice using one finger.
2. Tap  > **Security** > **Trusted credentials**.
3. Do one of the following:
 - To view a list of installed certificates, tap the **User** tab.

- To view a list of system certificates, tap the **System** tab.
4. Tap a certificate.
 5. Do one of the following:
 - To remove an installed certificate, tap **Remove**.
 - To turn off a system certificate, tap **Disable**.

To turn on a certificate that you turned off, on the **System** tab, tap the certificate. On the bottom of the certificate information screen, tap **Enable**.

Turn off access to the usage info for apps

Some apps and services monitor the active apps on your device. If you turn off access to this info, some apps might not work correctly.

1. Swipe down from the top of the screen once using two fingers, or twice using one finger.
2. Tap  > **Security** > **Apps with usage access**.
3. Tap an app and then turn off the **Permit usage access** switch.

Improving your security settings using DTEK

The DTEK by BlackBerry app is designed to help you monitor and control the level of security on your BlackBerry device. DTEK is preloaded on your device, and updates are available from the Google Play™ store.

Evaluating how security features are set up on your device

DTEK evaluates how or if you have set up security features on your device, including screen lock, factory reset protection, and remote device management.

DTEK assigns an overall security rating to your device along with a rating for each of the security features that it monitors. If a security feature receives a poor or fair rating, DTEK recommends how you can improve your security settings to achieve a better rating.

Monitoring how apps access your data

DTEK lets you see and control which third-party apps use features on your device to access your info. DTEK doesn't monitor preloaded apps or apps that your administrator might push to your device if you use your device for work.

DTEK monitors apps that:

- Take a picture or video using the camera
- Read, create, edit, or delete a contact

- Access the location of your device
- Send a text message (SMS or MMS) from your device
- Turn the microphone on or off



Get the latest info about DTEK at help.blackberry.com.

Google™ apps

Find help for Google™ apps

Your BlackBerry device is fully Android™, which gives you access to preloaded Google™ apps and millions of Android™ apps on Google Play™.

To get help for Google™ apps like Google Play™, YouTube, or Google Photos™, try any of the following:

- In the app, tap  or . Tap **Help** or **Help & feedback**.
- Visit [Google Help](#) and search for the app name.

Download an app on Google Play™

1. Open the Google Play™ store app.
2. If necessary, sign in with your Google™ account.
3. Browse or search for an app that you want to download.
4. Tap the app, and then tap **Install**.

About the Google™ app and Now on Tap

The Google™ app provides useful information when you need it through Google Now™ cards. Google Now™ cards contain personalized info, such as weather updates for your location, or directions to the next event on your agenda.

Now on Tap extends the features of the Google™ app to show you relevant information based on the app that you're using. For example, if you and a friend are using BBM to discuss meeting at a restaurant, Now on Tap can provide a card with ratings for the restaurant or directions to the restaurant. After you set up Now cards in the Google™ app, you can touch and hold  to access Now on Tap.

For more information about the Google app and Now on Tap, see the [Help for the Google app](#).

Google Chrome™

You can use Google Chrome™ to browse webpages, stream videos, and download files from the Internet.

To find help for Google Chrome™, in the Chrome app, tap  > **Help & feedback**, or visit the [Chrome for Android Help Center](#).

Tip: If you download a file from Google Chrome™, you can view the file in the Downloads app.

Google Maps™

Google Maps™ helps you find businesses, restaurants, and other places of interest, and can provide you with turn-by-turn directions to your destination.

To find help for Google Maps™, in the Maps app, tap  > **Help**, or visit the [Google Maps Help Center](#).

For information about changing your location settings, see the help for [Location services](#).

Google Messenger

You can use the Google Messenger app to send, receive, and manage text messages, including SMS and MMS messages.

To find help for Google Messenger, in the Messenger app, tap  > **Help & feedback**, or visit support.google.com and search for Messenger.

Legal notice

©2016 BlackBerry. Trademarks, including but not limited to BLACKBERRY, EMBLEM Design, BBM and BES are the trademarks or registered trademarks of BlackBerry Limited, the exclusive rights to which are expressly reserved.

Android™, Google™, Google Play™ and other marks are trademarks of Google Inc. Bluetooth is a trademark of Bluetooth SIG. HDMI is a trademark of HDMI Licensing, LLC. LTE is a trademark of European Telecommunications Standards Institute (ETSI). Microsoft is either a registered trademark or trademark of Microsoft Corporation in the United States and/or other countries. Qualcomm and IZat are trademarks of Qualcomm Incorporated. Wi-Fi, Wi-Fi CERTIFIED Miracast, Wi-Fi Direct, and Wi-Fi Protected Setup are trademarks of the Wi-Fi Alliance. Yahoo! is a trademark of Yahoo! Inc. All other trademarks are the property of their respective owners.

This documentation including all documentation incorporated by reference herein such as documentation provided or made available on the BlackBerry website is provided or made accessible "AS IS" and "AS AVAILABLE" and without condition, endorsement, guarantee, representation, or warranty of any kind by BlackBerry Limited and its affiliated companies ("BlackBerry") and BlackBerry assumes no responsibility for any typographical, technical, or other inaccuracies, errors, or omissions in this documentation. In order to protect BlackBerry proprietary and confidential information and/or trade secrets, this documentation may describe some aspects of BlackBerry technology in generalized terms. BlackBerry reserves the right to periodically change information that is contained in this documentation; however, BlackBerry makes no commitment to provide any such changes, updates, enhancements, or other additions to this documentation to you in a timely manner or at all.

This documentation might contain references to third-party sources of information, hardware or software, products or services including components and content such as content protected by copyright and/or third-party websites (collectively the "Third Party Products and Services"). BlackBerry does not control, and is not responsible for, any Third Party Products and Services including, without limitation the content, accuracy, copyright compliance, compatibility, performance, trustworthiness, legality, decency, links, or any other aspect of Third Party Products and Services. The inclusion of a reference to Third Party Products and Services in this documentation does not imply endorsement by BlackBerry of the Third Party Products and Services or the third party in any way.

EXCEPT TO THE EXTENT SPECIFICALLY PROHIBITED BY APPLICABLE LAW IN YOUR JURISDICTION, ALL CONDITIONS, ENDORSEMENTS, GUARANTEES, REPRESENTATIONS, OR WARRANTIES OF ANY KIND, EXPRESS OR IMPLIED, INCLUDING WITHOUT LIMITATION, ANY CONDITIONS, ENDORSEMENTS, GUARANTEES, REPRESENTATIONS OR WARRANTIES OF DURABILITY, FITNESS FOR A PARTICULAR PURPOSE OR USE, MERCHANTABILITY, MERCHANTABILITY, NON-INFRINGEMENT, SATISFACTORY QUALITY, OR TITLE, OR ARISING FROM A STATUTE OR CUSTOM OR A COURSE OF DEALING OR USAGE OF TRADE, OR RELATED TO THE DOCUMENTATION OR ITS USE, OR PERFORMANCE OR NON-PERFORMANCE OF ANY SOFTWARE, HARDWARE, SERVICE, OR ANY THIRD PARTY PRODUCTS AND SERVICES REFERENCED HEREIN, ARE HEREBY EXCLUDED. YOU MAY ALSO HAVE OTHER RIGHTS THAT VARY BY STATE OR PROVINCE. SOME JURISDICTIONS MAY NOT ALLOW THE EXCLUSION OR LIMITATION OF IMPLIED WARRANTIES AND CONDITIONS. TO THE EXTENT PERMITTED BY LAW, ANY IMPLIED WARRANTIES OR CONDITIONS RELATING TO THE DOCUMENTATION TO THE EXTENT THEY CANNOT BE EXCLUDED AS SET OUT ABOVE, BUT CAN BE LIMITED, ARE HEREBY LIMITED TO NINETY (90) DAYS FROM THE DATE YOU FIRST ACQUIRED THE DOCUMENTATION OR THE ITEM THAT IS THE SUBJECT OF THE CLAIM.

TO THE MAXIMUM EXTENT PERMITTED BY APPLICABLE LAW IN YOUR JURISDICTION, IN NO EVENT SHALL BLACKBERRY BE LIABLE FOR ANY TYPE OF DAMAGES RELATED TO THIS DOCUMENTATION OR ITS USE, OR PERFORMANCE OR NON-PERFORMANCE OF ANY SOFTWARE, HARDWARE, SERVICE, OR ANY THIRD PARTY

PRODUCTS AND SERVICES REFERENCED HEREIN INCLUDING WITHOUT LIMITATION ANY OF THE FOLLOWING DAMAGES: DIRECT, CONSEQUENTIAL, EXEMPLARY, INCIDENTAL, INDIRECT, SPECIAL, PUNITIVE, OR AGGRAVATED DAMAGES, DAMAGES FOR LOSS OF PROFITS OR REVENUES, FAILURE TO REALIZE ANY EXPECTED SAVINGS, BUSINESS INTERRUPTION, LOSS OF BUSINESS INFORMATION, LOSS OF BUSINESS OPPORTUNITY, OR CORRUPTION OR LOSS OF DATA, FAILURES TO TRANSMIT OR RECEIVE ANY DATA, PROBLEMS ASSOCIATED WITH ANY APPLICATIONS USED IN CONJUNCTION WITH BLACKBERRY PRODUCTS OR SERVICES, DOWNTIME COSTS, LOSS OF THE USE OF BLACKBERRY PRODUCTS OR SERVICES OR ANY PORTION THEREOF OR OF ANY AIRTIME SERVICES, COST OF SUBSTITUTE GOODS, COSTS OF COVER, FACILITIES OR SERVICES, COST OF CAPITAL, OR OTHER SIMILAR PECUNIARY LOSSES, WHETHER OR NOT SUCH DAMAGES WERE FORESEEN OR UNFORESEEN, AND EVEN IF BLACKBERRY HAS BEEN ADVISED OF THE POSSIBILITY OF SUCH DAMAGES.

TO THE MAXIMUM EXTENT PERMITTED BY APPLICABLE LAW IN YOUR JURISDICTION, BLACKBERRY SHALL HAVE NO OTHER OBLIGATION, DUTY, OR LIABILITY WHATSOEVER IN CONTRACT, TORT, OR OTHERWISE TO YOU INCLUDING ANY LIABILITY FOR NEGLIGENCE OR STRICT LIABILITY.

THE LIMITATIONS, EXCLUSIONS, AND DISCLAIMERS HEREIN SHALL APPLY: (A) IRRESPECTIVE OF THE NATURE OF THE CAUSE OF ACTION, DEMAND, OR ACTION BY YOU INCLUDING BUT NOT LIMITED TO BREACH OF CONTRACT, NEGLIGENCE, TORT, STRICT LIABILITY OR ANY OTHER LEGAL THEORY AND SHALL SURVIVE A FUNDAMENTAL BREACH OR BREACHES OR THE FAILURE OF THE ESSENTIAL PURPOSE OF THIS AGREEMENT OR OF ANY REMEDY CONTAINED HEREIN; AND (B) TO BLACKBERRY AND ITS AFFILIATED COMPANIES, THEIR SUCCESSORS, ASSIGNS, AGENTS, SUPPLIERS (INCLUDING AIRTIME SERVICE PROVIDERS), AUTHORIZED BLACKBERRY DISTRIBUTORS (ALSO INCLUDING AIRTIME SERVICE PROVIDERS) AND THEIR RESPECTIVE DIRECTORS, EMPLOYEES, AND INDEPENDENT CONTRACTORS.

IN ADDITION TO THE LIMITATIONS AND EXCLUSIONS SET OUT ABOVE, IN NO EVENT SHALL ANY DIRECTOR, EMPLOYEE, AGENT, DISTRIBUTOR, SUPPLIER, INDEPENDENT CONTRACTOR OF BLACKBERRY OR ANY AFFILIATES OF BLACKBERRY HAVE ANY LIABILITY ARISING FROM OR RELATED TO THE DOCUMENTATION.

Prior to subscribing for, installing, or using any Third Party Products and Services, it is your responsibility to ensure that your airtime service provider has agreed to support all of their features. Some airtime service providers might not offer Internet browsing functionality with a subscription to the BlackBerry® Internet Service. Check with your service provider for availability, roaming arrangements, service plans and features. Installation or use of Third Party Products and Services with BlackBerry's products and services may require one or more patent, trademark, copyright, or other licenses in order to avoid infringement or violation of third party rights. You are solely responsible for determining whether to use Third Party Products and Services and if any third party licenses are required to do so. If required you are responsible for acquiring them. You should not install or use Third Party Products and Services until all necessary licenses have been acquired. Any Third Party Products and Services that are provided with BlackBerry's products and services are provided as a convenience to you and are provided "AS IS" with no express or implied conditions, endorsements, guarantees, representations, or warranties of any kind by BlackBerry and BlackBerry assumes no liability whatsoever, in relation thereto. Your use of Third Party Products and Services shall be governed by and subject to you agreeing to the terms of separate licenses and other agreements applicable thereto with third parties, except to the extent expressly covered by a license or other agreement with BlackBerry.

The terms of use of any BlackBerry product or service are set out in a separate license or other agreement with BlackBerry applicable thereto. NOTHING IN THIS DOCUMENTATION IS INTENDED TO SUPERSEDE ANY EXPRESS WRITTEN AGREEMENTS OR WARRANTIES PROVIDED BY BLACKBERRY FOR PORTIONS OF ANY BLACKBERRY PRODUCT OR SERVICE OTHER THAN THIS DOCUMENTATION.

The information provided in this guide is applicable to the following smartphone models:

- STV100-1 / RHK211LW
- STV100-2 / RHT181LW
- STV100-3 / RHL211LW
- STV100-4 / RHM181LW

BlackBerry Limited
2200 University Avenue East
Waterloo, Ontario
Canada N2K 0A7

BlackBerry UK Limited
200 Bath Road
Slough, Berkshire SL1 3XE
United Kingdom

Published in Canada